

MP-Leuchten



*CD im Katalog
CD in catalogue*



Katalog 2004 – 2005



Diese Seite: **Subra** 1 x 150 W E27
Code: LD1850.11.S500.1W

Titelseite: **Carmen** 6 x 60 W E27
Code: S163R.16.A350.5W

MP-Leuchten



Inhaltsverzeichnis / Content

Seite / Page



Historic Line

Massives Messing
Massive brass

2



Kristallglas
Crystal glass

6



Modern Line

Moderne Metallleuchten mit Halogen
Modern metal with halogene

11



Mit Glas
With glass

19

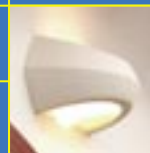

Gipsleuchten
Plaster lamps

32

Alle Leuchten werden ohne Leuchtmittel ausgeliefert!
All luminaires will be delivered without bulbs!

Handgemachte Leuchten aus massivem Messing mit Kristallglas

Hand made massive brass with crystal glass



Code: Jarmila

↑ 35cm, Ø 52cm
5 x 40 W E14

Leuchte ist handgemacht aus massivem Messingguss in Ausführung „Altmessing“, Kristallglas.

Luminary is hand made from massive brass, color „old brass“.



Code: Viktoria

↑ 44cm, Ø 81cm
16 x 40 W E14



Code: Alice

↑ 35 cm, Ø 67 cm
6x40W E14

Handgemachte Leuchten aus massivem Messing mit Kristallglas.
Hand made massive brass with crystal glass.

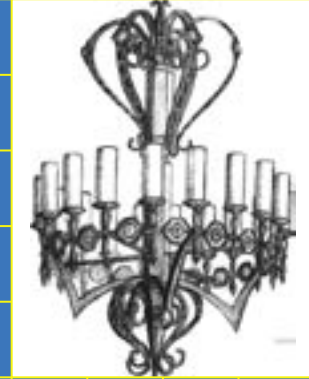
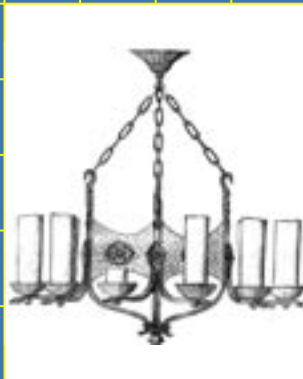

Code: Sarka II.

↑ 35 cm, ↔ 26 cm, ↗ 23 cm
2 x 40 W E14



Handgemachte Messing-Leuchten mit
Glasperlen aus Kristallglas.
Hand made brass luminary with polished
crystal glass pearls.



Code: Erika ↓ 32 cm, Ø 16 cm
1 x 40 W E14



Code: Marta ↓ 35 cm, Ø 50 cm
6 x 40 W E14

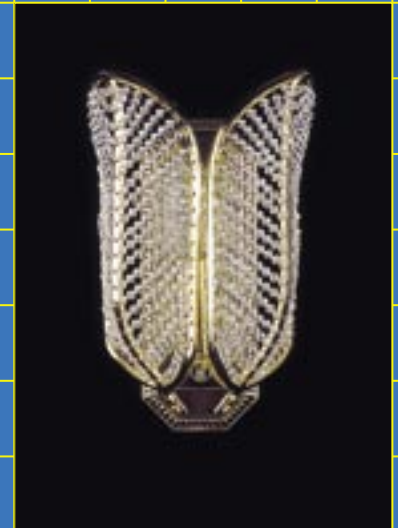

Code: Ema ↓ 23 cm, ↔ 14 cm, ↗ 12 cm
1 x 40 W E14



Code: Sandra ↓ 14 cm, Ø 50 cm
6 x 40 W E14 + 1 x 40 W E14



Code: Apolena ↑ 50 cm, Ø 35 cm
1 x 60W E27

Mundgeblasenes blaues Glas mit poliertem Messing.

Hand blown blue glass with polished brass s.



Code: Andromeda ↑ 30 cm, ↔ 19 cm
1 x 60 W E27

Leuchte ist handgemacht aus massivem Messingguss in Ausführung „Altmessing“, Kristallglas.

Luminary is hand made from massive brass, color „old brass“.



Code: Athena ↑ 37 cm, Ø 19 cm
1 x 60 W E27

Leuchte ist handgemacht aus massivem Messingguss in Ausführung „Altmessing“, Kristallglas.

Luminary is hand made from massive brass, color „old brass“.



Code: Naharja 6

Wir können Ihnen auch Sondergrößen anbieten (z.B. für Hotels).

We also can offer you special luminaries.

Genießen Sie die Atmosphäre der Kronleuchter, die von böhmischen Glasmeistern seit Jahrhunderten mit viel Sinn fürs Detail, Liebe und Können hergestellt werden. Lüster und Glas aus Böhmen finden Sie auf der ganzen Welt in den luxuriösesten Hotels und Privathäusern. Wir können auf Wunsch auch individuelle Leuchten bauen.

1. Basic Class – CRYSTAL KRONLEUCHTER

Diese Kronleuchter sind aus Kristallglas in Kombination mit Behang aus Bleikristallglas (30%) gemacht. Die Gestelle sind aus massivem Messing in den Oberflächen „Messing poliert oder Nickel poliert“ lieferbar.

2. Medium Class – EMAILKRONLEUCHTER

Mundgeblasene Kristallkomponenten sind mit Hochemail und Gold dekoriert. Metallteile sind aus poliertem Messing und der Behang ist teilweise aus 30%-igem Bleikristallglas.

3. TOP Class – CAESAR KRONLEUCHTER

Bei diesen hochwertigen Kristalllüstern wird mundgeblasenes, handgeschliffenes Kristallglas mit 24%-igem Bleianteil verwendet. Der Kristallbehang ist aus 30%-igem Bleikristall gemacht.

Enjoy the atmosphere of the crystal chandeliers, which are being produced for many centuries from Czech masters with love for detail and skill. Original Bohemian Chandeliers you would find around the world in the most luxurious hotels and houses.

1. Basic Class – CRYSTAL CHANDELIERS

Glass components of chandeliers are made from press crystal. Metal components are from furbished brass and trimmings are machine cutted - with 30% lead content.

2. Medium Class – ENAMELLED CHANDELIERS

Hand blown crystal components are decorated by high enamel and by gold. Metal components are from furbished brass and trimmings are machine cutted - with 30% lead content.

3. Top Class – CAESAR CHANDELIERS

Hand blown crystal components are made from 24% lead hand cutted crystal. Metal components are from furbished brass and trimming are machine cutted - with 30% lead content.



CH-06 Crystal-A

Crystal Kronleuchter / Crystal Chandeliers

↑ 51 cm, Ø 60 cm
6 x 40 W E14

CH-06 Crystal-AG

Crystal Kronleuchter / Crystal Chandeliers

↑ 51 cm, Ø 60 cm
6 x 40 W E14



CH-06 Crystal-B

Crystal Kronleuchter / Crystal Chandeliers

↑ 48 cm, Ø 46 cm
6 x 40 W E14

CH-06 Crystal-FS

Crystal Kronleuchter / Crystal Chandeliers

↑ 51 cm, Ø 60 cm
6 x 40 W E14



CH-06V Crystal-pink wine
Crystal Kronleuchter / Crystal Chandeliers

↓ 53 cm, Ø 62 cm
6 x 40 W E14



CH-08 Crystal-DS
Crystal Kronleuchter / Crystal Chandeliers

↓ 51 cm, Ø 60 cm
8 x 40 W E14



CH-08 Crystal-2BK
Crystal Kronleuchter / Crystal Chandeliers

↓ 54 cm, Ø 62 cm
8 x 40 W E14



CH-08 Crystal-A
Crystal Kronleuchter / Crystal Chandeliers

↓ 51 cm, Ø 60 cm
8 x 40 W E14



CH-08 Crystal-AG
Crystal Kronleuchter / Crystal Chandeliers

↓ 51 cm, Ø 60 cm
8 x 40 W E14



CH-08 Crystal-K
Crystal Kronleuchter / Crystal Chandeliers

↓ 57 cm, Ø 62 cm
8 x 40 W E14



CH-08 Crystal-KG

Crystal Kronleuchter / Crystal Chandeliers

↓ 57 cm, Ø 62 cm
8 x 40 W E14



CH-08 Crystal-NB

Crystal Kronleuchter / Crystal Chandeliers

↓ 47 cm, Ø 62 cm
8 x 40 W E14



CH-08V Crystal-white wine

Crystal Kronleuchter / Crystal Chandeliers

↓ 53 cm, Ø 62 cm
8 x 40 W E14



CH-12 Crystal-A

Crystal Kronleuchter / Crystal Chandeliers

↓ 53 cm, Ø 66 cm
12 x 40 W E14



CH-12 Crystal-2DK

Crystal Kronleuchter / Crystal Chandeliers

↓ 80 cm, Ø 80 cm
12 x 40 W E14



CH-15 Crystal-K

Crystal Kronleuchter / Crystal Chandeliers

↓ 75 cm, Ø 88 cm
15 x 40 W E14



CH-24 Crystal-XXL

Crystal Kronleuchter / Crystal Chandeliers

↓ 102 cm, Ø 112 cm
24 x 40 W E14



CH-08 Crystal fond-gold

Emaillronleuchter / Enamelled Chandeliers

↓ 53 cm, Ø 62 cm
8 x 40 W E14



CH-12 Crystal fond 6+6-pink

Emaillronleuchter / Enamelled Chandeliers

↓ 53 cm, Ø 66 cm
12 x 40 W E14



CH-12 Crystal fond 8+4 BIG-gold

Emaillronleuchter / Enamelled Chandeliers

↓ 74 cm, Ø 80 cm
12 x 40 W E14



W-01 High enamel-white

Emaillronleuchter / Enamelled Chandeliers

↓ 34 cm, Ø 12 cm
1 x 40 W E14



W-03 Crystal fond-gold

Emaillronleuchter / Enamelled Chandeliers

↓ 44 cm, Ø 34 cm
3 x 40 W E14



CH-06 Visu-blue ↓ 62 cm, Ø 70 cm
Caesar Kronleuchter / Caesar Chandeliers 6 x 40 W E14



CH-06 Visu-green ↓ 62 cm, Ø 70 cm
Caesar Kronleuchter / Caesar Chandeliers 6 x 40 W E14



CH-06 Visu-red ↓ 62 cm, Ø 70 cm
Caesar Kronleuchter / Caesar Chandeliers 6 x 40 W E14



CH-12 Crystal-Gold ↓ 73 cm, Ø 68 cm
Caesar Kronleuchter / Caesar Chandeliers 12 x 40 W E14



CH-08 Flowerbud-A blue ↓ 64 cm, Ø 58 cm
Caesar Kronleuchter / Caesar Chandeliers 8 x 40 W E14



CH-06 Galaxy-blue ↓ 55 cm, Ø 60 cm
Caesar Kronleuchter / Caesar Chandeliers 6 x 40 W E14

Wir weisen darauf hin, daß die Kontakte bei NV-Halogen (12V) unbedingt fest angezogen werden müssen. Ansonsten Brandgefahr!

We would like to inform you, that it is very important, that all screws must be tightend with the 12V halogen fittings and systems. Otherwise danger of fire!



D ANE AP6Q 16 O13

↓ 13cm, ↔ 35cm, ↗ 14cm
Max 3 x 20 W GY 6,35

D ANE AP3Q 16

↓ 18cm, ↔ 40cm, ↗ 21cm
Max 3 x 20 W GY 6,35



D ANE PI 16 H15

↓ 170cm
∅ 22cm
Max 3 x 50 W GY 6,35

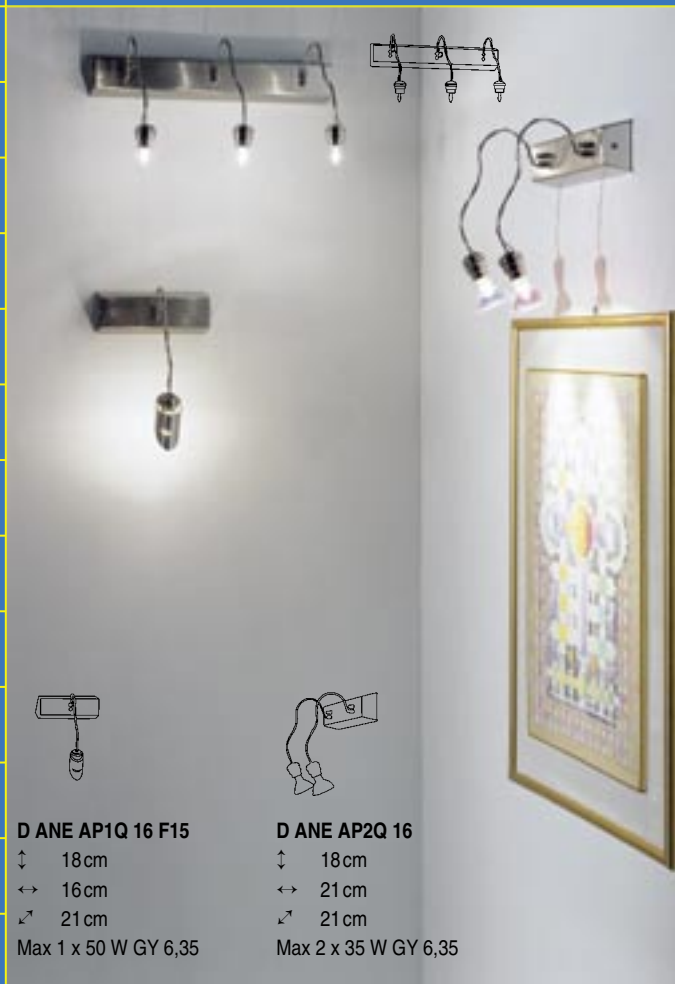

D ANE AP1Q 16 F15

↓ 18cm
↔ 16cm
↗ 21cm
Max 1 x 50 W GY 6,35

D ANE AP2Q 16

↓ 18cm
↔ 21cm
↗ 21cm
Max 2 x 35 W GY 6,35



D ANE LU2 16 E04

D ANE LU 16 O23

↑ 40 cm, ↔ 20 cm
Max 2 x 35 W GY 6,35

↑ 30 cm, ↔ 14 cm
Max 1 x 50 W GY 6,35

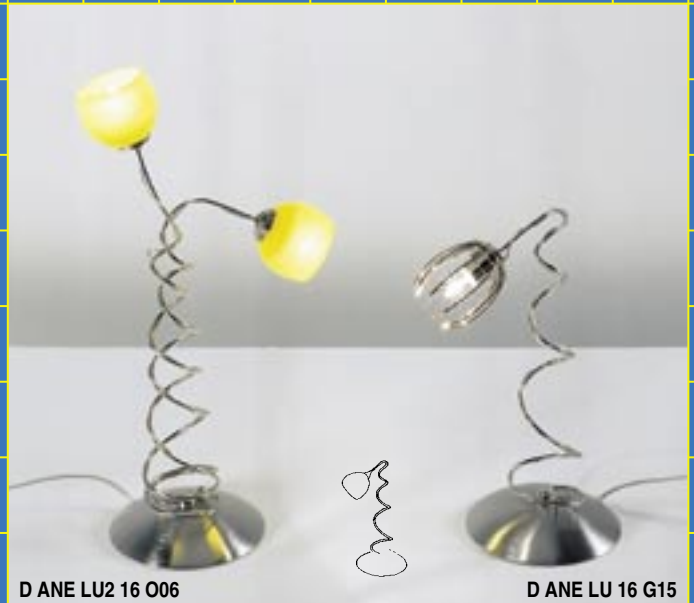

D ANE LU2 16 O06

D ANE LU 16 G15

↑ 40 cm, ↔ 20 cm
Max 2 x 35 W GY 6,35

↑ 30 cm, ↔ 14 cm
Max 1 x 50 W GY 6,35



D ANE SO12 16 6x M01 + 6x M02

↑ 75-100 cm, Ø 63 cm
Max 12 x 20 W GY 6,35



D ANE SO3 16 L25 ↑ 65-98 cm, Ø 35 cm
Max 3 x 20 W GY 6,35



D ANE SO9 16 3x O04 + 6x F15

↑ 75-100 cm, Ø 63 cm
Max 9 x 35 W GY 6,35



D ANE SO6 16 I15 ↓ 75-100cm, Ø 60cm
Max 6 x 50 W GY 6,35



D ANE PL3 16 ↓ 22cm, Ø 35cm
Max 3 x 20 W GY 6,35

D ANE AP2 16 O04

↓ 13cm
↔ 47cm
↗ 15cm

Max 2 x 35 W GY 6,35



D ANE AP3 16 I15

↓ 22cm
↔ 47cm
↗ 20cm

Max 3 x 20 W GY 6,35



D ANE AP1 16 L25

↓ 22cm, ↔ 13cm, ↗ 20cm
Max 1 x 50 W GY 6,35



D ANE PL6 16 O13 ↓ 37cm, ↔ 40cm
Max 6 x 20 W GY 6,35



D ANE PL9 16 6x O06 + 3x O12
↓ 37cm, Ø 63cm
Max 9 x 20 W GY 6,35



D ANE PL12 16 L25

↓ 37cm, ↔ 63cm
Max 12 x 20 W GY 6,35



D ANE PL18 16 H15

↑ 38cm, Ø 80cm
Max 18 x 10 W GY 6,35



D ANE PL24 16 O13

↑ 38cm, Ø 90cm
Max 24 x 10 W GY 6,35



D ANE PL30 16 F15

↑ 41cm, Ø 90cm
Max 30 x 10 W GY 6,35



D ANE PL42 16 O04

↑ 45cm, Ø 105cm
Max 42 x 10 W GY 6,35



D ART PL42 16 O13

↑ 40 cm, Ø 160 cm
Max 42 x 10 W GY 6,35



D ART PL30 16 6x O13 + 3x O10 + 6x O26 + 6x O12 + 6x O06 + 3x O23

↑ 35 cm, Ø 120 cm
Max 30 x 10 W GY 6,35



D ART PL24 16 12x E04 + 12x L25

↑ 32 cm, Ø 90 cm
Max 24 x 10 W GY 6,35



D ART PL12 16 O04

↑ 29 cm, Ø 57 cm
Max 12 x 20 W GY 6,35



D ART PL9 16 L25

↑ 29cm, Ø 57cm
Max 9 x 20 W GY 6,35



D ART PL6 16 3x O10 + 3x O23

↑ 29cm, Ø 52cm
Max 6 x 20 W GY 6,35



D ART PL3 16 F15

↑ 20cm, Ø 32cm
Max 3 x 20 W GY 6,35



D ART PL18 16 6x O06 + 6x O13 + 6x O26

↑ 32cm, Ø 90cm
Max 18 x 10 W GY 6,35



D ART LT 16 O13

↑ 35 cm, ↔ 44 cm
Max 1 x 50 W GY 6,35

D ART LT 16 G15

↑ 35 cm, ↔ 44 cm
Max 1 x 50 W GY 6,35

D ART AP2 16 I15

↑ 27 cm
↔ 40 cm
↗ 15 cm
Max 2 x 35 W GY 6,35

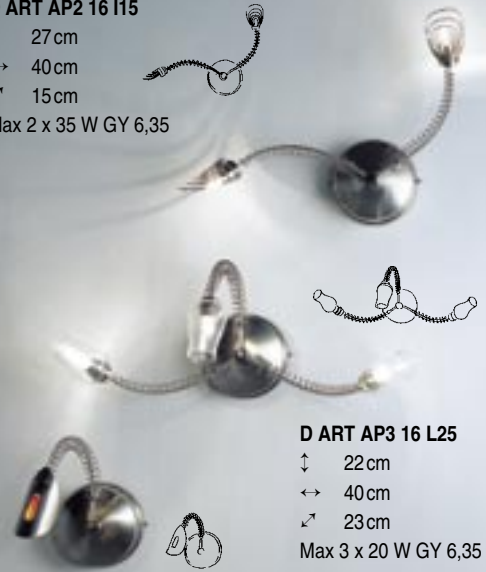

D ART AP3 16 L25

↑ 22 cm
↔ 40 cm
↗ 23 cm
Max 3 x 20 W GY 6,35

D ART AP1 16 E26

↑ 22 cm, ↔ 13 cm, ↗ 23 cm
Max 1 x 50 W GY 6,35



D ART SO12 16 I15

↑ 70-100 cm, Ø 60 cm
Max 12 x 20 W GY 6,35



D ART SO9 16 G15 ↑ 70-100 cm, Ø 60 cm
Max 9 x 35 W GY 6,35



D ART SO6 16 O26

↑ 70-100 cm, Ø 50 cm
Max 6 x 50 W GY 6,35



D ART SO3 16 H15

↑ 50-90cm, Ø 42cm
Max 3 x 20 W GY 6,35



D VENE PL 08 13

↓ 17cm
Ø 70cm
Max 5 x 60 W E27
Chrome / frosted glass

D VENE PL1 08 13

↓ 15cm
Ø 51cm
Max 3 x 60 W E27
Chrome / frosted glass

D VENE PL2 08 13

↓ 13cm
Ø 41cm
Max 2 x 60 W E27
Chrome / frosted glass



D VENE SOA 08 13

↓ 70-100cm
Ø 70cm
Max 3 x 100 W E27
Chrome / frosted glass

D VENE SO1A 08 13

↓ 68-90cm
Ø 51cm
Max 1 x 100 W E27
Chrome / frosted glass

D VENE SO2A 08 13

↓ 68-90cm
Ø 41cm
Max 1 x 100 W E27
Chrome / frosted glass



D VENE SOB 16 13

↓ 57-110cm
Ø 70cm
Max 1 x 150 W E27
Chrome / frosted glass

D VENE SO1B 16 13

↓ 57-110cm
Ø 51cm
Max 1 x 100 W E27
Chrome / frosted glass

D VENE SO2B 16 13

↓ 57-110cm
Ø 41cm
Max 1 x 100 W E27
Chrome / frosted glass

Moderne Glasleuchten

Bei diesen Leuchten handelt es sich um ein hochwertiges, dreischichtiges, mundgeblasenes Glas (Triplex-Opalglas). Kleine Unebenheiten sind ein Zeichen für die Wertigkeit der Gläser. Das dreischichtige Glas (Kristall-Opal-Kristallglas) verleiht dem Licht eine besondere Atmosphäre und hat eine günstige Lichtverteilung.

Modern Glass

These luminaries are hand made from hand blown triplex-opal-glass. This means that the glass is put together from three layers of crystal-opal-crystal glass. This glass produces a special and cozy atmosphere.

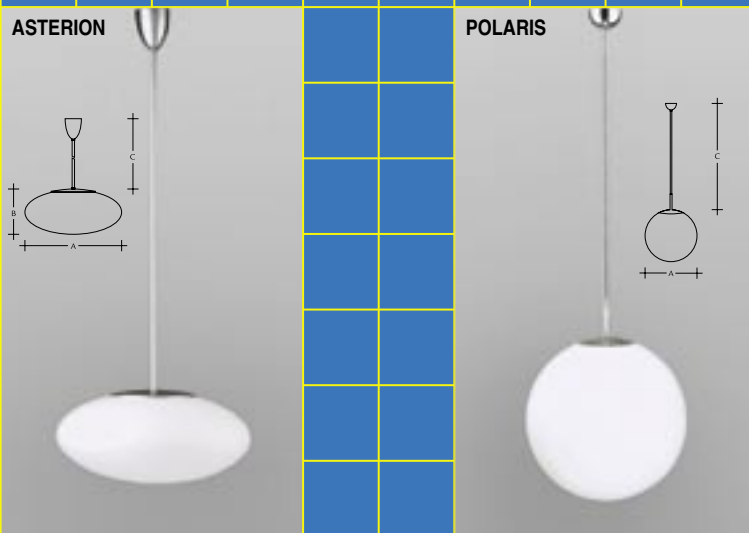

POLARIS

Weiß / White

Type			A	C	Gewicht Weight
ZT111.300	1 x 100 W	E27	30	100	4000
ZT211.300 VVG	1 x 26 W	G24d-3	30	100	4500
ZT211.300 EVG	1 x 26 W	G24q-4	30	100	4100
ZT111.400	1 x 150 W	E27	40	100	4800
ZT212.400 VVG	2 x 26 W	G24d-3	40	100	5700
ZT212.400 EVG	2 x 26 W	G24q-4	40	100	4900
ZT111.500	1 x 200 W	E27	50	100	11000
ZT213.500 VVG	4 x 26 W	G24d-3	50	100	13000
ZT213.500 EVG	4 x 26 W	G24q-4	50	100	11500

Verchromt / Chrom

Type			A	C	Gewicht Weight
ZT121.300	1 x 100 W	E27	30	100	4000
ZT221.300 VVG	1 x 26 W	G24d-3	30	100	4500
ZT221.300 EVG	1 x 26 W	G24q-4	30	100	4100
ZT121.400	1 x 150 W	E27	40	100	4800
ZT222.400 VVG	2 x 26 W	G24d-3	40	100	5700
ZT222.400 EVG	2 x 26 W	G24q-4	40	100	4900
ZT121.500	1 x 200 W	E27	50	100	11000
ZT223.500 VVG	4 x 26 W	G24d-3	50	100	13000
ZT223.500 EVG	4 x 26 W	G24q-4	50	100	11500

Messing / Brass

Type			A	C	Gewicht Weight
ZT131.300	1 x 100 W	E27	30	100	4000
ZT231.300 VVG	1 x 26 W	G24d-3	30	100	4500
ZT231.300 EVG	1 x 26 W	G24q-4	30	100	4100
ZT131.400	1 x 150 W	E27	40	100	4800
ZT232.400 VVG	2 x 26 W	G24d-3	40	100	5700
ZT232.400 EVG	2 x 26 W	G24q-4	40	100	4900
ZT131.500	1 x 200 W	E27	50	100	11000
ZT233.500 VVG	4 x 26 W	G24d-3	50	100	13000
ZT233.500 EVG	4 x 26 W	G24q-4	50	100	11500

ASTERION

Weiß / White

Type			A	B	C	Gewicht Weight
ZT111.A550	1 x 150 W	E27	55	25	100	900
ZT212.A550 VVG	2 x 26 W	G24d-3	55	25	100	1050
ZT216.A550 EVG	2 x 42 W	GX24q-4	55	25	100	900

Verchromt / Chrom

Type			A	B	C	Gewicht Weight
ZT121.A550	1 x 150 W	E27	55	25	100	9000
ZT222.A550 VVG	2 x 26 W	G24d-3	55	25	100	10500
ZT226.A550 EVG	2 x 42 W	GX24q-4	55	25	100	9000

Messing / Brass

Type			A	B	C	Gewicht Weight
ZT131.A550	1 x 150 W	E27	55	25	100	9000
ZT232.A550 VVG	2 x 26 W	G24d-3	55	25	100	10500
ZT236.A550 EVG	2 x 42 W	GX24q-4	55	25	100	9000

CAPELLA



CAPELLA

Type				A	B	C	Gewicht Weight
S19.111.R3	1x	75 W	E27	22	19	17	1500
S19.211.R3 VVG	1x	13 W	G24d-1	22	19	17	2000
S19.211.R3 EVG	1x	13 W	G24q-1	22	19	17	1600
S24.111.R4	1x	100 W	E27	28	24	21	2700
S24.212.R4 VVG	2x	13 W	G24d-1	28	24	21	3300
S24.212.R4 EVG	2x	13 W	G24q-1	28	24	21	3000
S24.213.R4 VVG	2x	18 W	G24d-2	28	24	21	3300
S24.213.R4 EVG	2x	18 W	G24q-2	28	24	21	3000



CAPELLA PLUS



CAPELLA PLUS

Weiß / White

Type				A	B	C	Gewicht Weight
S19.111.R3L	1x	75 W	E27	22	23	17	1700
S19.211.R3L VVG	1x	13 W	G24d-1	22	23	17	2100
S19.211.R3L EVG	1x	13 W	G24q-1	22	23	17	2000
S24.111.R4L	1x	100 W	E27	28	29	21	2900
S24.212.R4L VVG	2x	13 W	G24d-1	28	29	21	3500
S24.212.R4L EVG	2x	13 W	G24q-1	28	29	21	3200
S24.213.R4L VVG	2x	18 W	G24d-2	28	29	21	3500
S24.213.R4L EVG	2x	18 W	G24q-2	28	29	21	3200

Verchromt / Chrom

Type				A	B	C	Gewicht Weight
S19.121.R3L	1x	75 W	E27	22	23	17	1700
S19.221.R3L VVG	1x	13 W	G24d-1	22	23	17	2100
S19.221.R3L EVG	1x	13 W	G24q-1	22	23	17	2000
S24.121.R4L	1x	100 W	E27	28	29	21	2900
S24.222.R4L VVG	2x	13 W	G24d-1	28	29	21	3500
S24.222.R4L EVG	2x	13 W	G24q-1	28	29	21	3200
S24.223.R4L VVG	2x	18 W	G24d-2	28	29	21	3500
S24.223.R4L EVG	2x	18 W	G24q-2	28	29	21	3200

Messing / Brass

Type				A	B	C	Gewicht Weight
S19.131.R3L	1x	75 W	E27	22	23	17	1700
S19.231.R3L VVG	1x	13 W	G24d-1	22	23	17	2100
S19.231.R3L EVG	1x	13 W	G24q-1	22	23	17	2000
S24.131.R4L	1x	100 W	E27	28	29	21	2900
S24.232.R4L VVG	2x	13 W	G24d-1	28	29	21	3500
S24.232.R4L EVG	2x	13 W	G24q-1	28	29	21	3200
S24.233.R4L VVG	2x	18 W	G24d-2	28	29	21	3500
S24.233.R4L EVG	2x	18 W	G24q-2	28	29	21	3200

LEDA

LEDA

Type	A	B	C	Gewicht Weight
S19.111.JS22	1x 75 W	E27	22 19 14	950
S19.211.JS22 VVG	1x 13 W	G24d-1	22 19 14	1300
S19.211.JS22 EVG	1x 13 W	G24q-1	22 19 14	1200
S24.111.JS28	1x 100 W	E27	28 24 17	1430
S24.212.JS28 VVG	2x 13 W	G24d-1	28 24 17	2200
S24.212.JS28 EVG	2x 13 W	G24q-1	28 24 17	1700
S29.112.JS33	2x 75 W	E27	33 29 20	2800
S29.211.JS33 VVG	2x 18 W	G24d-2	33 29 20	3500
S29.211.JS33 EVG	2x 18 W	G24q-2	33 29 20	3100
S37.111.JS41	2x 75 W	E27	41,5 37 23,5	3600
S37.215.JS41 VVG	2x 26 W	G24d-3	41,5 37 23,5	4600
S37.215.JS41 EVG	2x 26 W	G24q-3	41,5 37 23,5	3800

LEDA PLUS
Weiß / White

Type	A	B	C	Gewicht Weight
S19.111.JS22L	1x 75 W	E27	22 23 14	1150
S19.211.JS22L VVG	1x 13 W	G24d-1	22 23 14	1500
S19.211.JS22L EVG	1x 13 W	G24q-1	22 23 14	1300
S24.111.JS28L	1x 100 W	E27	28 29 17	1900
S24.212.JS28L VVG	2x 13 W	G24d-1	28 29 17	2600
S24.212.JS28L EVG	2x 13 W	G24q-1	28 29 17	2100
S29.112.JS33L	2x 75 W	E27	33 34 20	3200
S29.211.JS33L VVG	2x 18 W	G24d-2	33 34 20	3900
S29.211.JS33L EVG	2x 18 W	G24q-2	33 34 20	3500
S 37.111.JS41L	2x 75 W	E27	41,5 43 23,5	4000
S 37.215.JS41L VVG	2x 26 W	G24d-3	41,5 43 23,5	5000
S 37.215.JS41L EVG	2x 26 W	G24q-3	41,5 43 23,5	4200

Verchromt / Chrom

Type	A	B	C	Gewicht Weight
S19.121.JS22L	1x 75 W	E27	22 23 14	1150
S19.221.JS22L VVG	1x 13 W	G24d-1	22 23 14	1500
S19.221.JS22L EVG	1x 13 W	G24q-1	22 23 14	1300
S24.121.JS28L	1x 100 W	E27	28 29 17	1900
S24.222.JS28L VVG	2x 13 W	G24d-1	28 29 17	2600
S24.222.JS28L EVG	2x 13 W	G24q-1	28 29 17	2100
S29.122.JS33L	2x 75 W	E27	33 34 20	2800
S29.221.JS33L VVG	2x 18 W	G24d-2	33 34 20	3900
S29.221.JS33L EVG	2x 18 W	G24q-2	33 34 20	3500
S 37.121.JS41L	2x 75 W	E27	41,5 43 23,5	4000
S 37.225.JS41L VVG	2x 26 W	G24d-3	41,5 43 23,5	5000
S 37.225.JS41L EVG	2x 26 W	G24q-3	41,5 43 23,5	4200

LEDA PLUS

Messing / Brass

Type	A	B	C	Gewicht Weight
S19.131.JS22L	1x 75 W	E27	22 23 14	1150
S19.231.JS22L VVG	1x 13 W	G24d-1	22 23 14	1500
S19.231.JS22L EVG	1x 13 W	G24q-1	22 23 14	1300
S24.131.JS28L	1x 100 W	E27	28 29 17	1900
S24.232.JS28L VVG	2x 13 W	G24d-1	28 29 17	2600
S24.232.JS28L EVG	2x 13 W	G24q-1	28 29 17	2100
S29.132.JS33L	2x 75 W	E27	33 34 20	2800
S29.231.JS33L VVG	2x 18 W	G24d-2	33 34 20	3900
S29.231.JS33L EVG	2x 18 W	G24q-2	33 34 20	3500
S 37.131.JS41L	2x 75 W	E27	41,5 43 23,5	4000
S 37.235.JS41L VVG	2x 26 W	G24d-3	41,5 43 23,5	5000
S 37.235.JS41L EVG	2x 26 W	G24q-3	41,5 43 23,5	4200

SINOPE



SINOPE

Type			A	B	C	Gewicht Weight
CS19.111	1x 60 W	E27	23	12	14,5	1000
CS19.211 VVG	1x 13 W	G24d-1	23	12	14,5	1430
CS19.211 EVG	1x 13 W	G24q-1	23	12	14,5	1230
CS32.111	2x 60 W	E27	35	18,5	20	3250
CS32.211 VVG	2x 18 W	G24d-2	35	18,5	20	4250
CS32.211 EVG	2x 18 W	G24q-2	35	18,5	20	3650



HIMÁLIA PLUS



HIMÁLIA PLUS

Weiß / White

Type			A	B	C	Gewicht Weight
S24.111.V2L	1x 100 W	E27	28	29	20	2400
S24.212.V2L VVG	2x 13 W	G24d-1	28	29	20	2800
S24.212.V2L EVG	2x 13 W	G24q-1	28	29	20	2300
S24.112.V3L	2x 60 W	E27	33	34	25	3100
S24.213.V3L VVG	2x 18 W	G24d-2	33	34	25	3800
S24.213.V3L EVG	2x 18 W	G24q-2	33	34	25	3400
S37.111.V4L	2x 75 W	E27	41,5	43	29	5500
S37.215.V4L VVG	2x 26 W	G24d-3	41,5	43	29	5700
S37.215.V4L EVG	2x 26 W	G24q-3	41,5	43	29	5600

Verchromt / Chrom

Type			A	B	C	Gewicht Weight
S24.121.V2L	1x 100 W	E27	28	29	20	2400
S24.222.V2L VVG	2x 13 W	G24d-1	28	29	20	2800
S24.222.V2L EVG	2x 13 W	G24q-1	28	29	20	2300
S24.122.V3L	2x 60 W	E27	33	34	25	3100
S24.223.V3L VVG	2x 18 W	G24d-2	33	34	25	3800
S24.223.V3L EVG	2x 18 W	G24q-2	33	34	25	3400
S37.121.V4L	2x 75 W	E27	41,5	43	29	5500
S37.225.V4L VVG	2x 26 W	G24d-3	41,5	43	29	5700
S37.225.V4L EVG	2x 26 W	G24q-3	41,5	43	29	5600



Messing / Brass

Type			A	B	C	Gewicht Weight
S24.131.V2L	1x 100 W	E27	28	29	20	2400
S24.232.V2L VVG	2x 13 W	G24d-1	28	29	20	2800
S24.232.V2L EVG	2x 13 W	G24q-1	28	29	20	2300
S24.132.V3L	2x 60 W	E27	33	34	25	3100
S24.233.V3L VVG	2x 18 W	G24d-2	33	34	25	3800
S24.233.V3L EVG	2x 18 W	G24q-2	33	34	25	3400
S37.131.V4L	2x 75 W	E27	41,5	43	29	5500
S37.235.V4L VVG	2x 26 W	G24d-3	41,5	43	29	5700
S37.235.V4L EVG	2x 26 W	G24q-3	41,5	43	29	5600

CHARON

CHARON

Type	A	B	C	Gewicht Weight
S24.111.T2	1x 100 W	E27	28 24	12,5 1300
S24.211.T2 VVG	1x 18 W	G24d-2	28 24	12,5 1800
S24.211.T2 EVG	1x 18 W	G24q-2	28 24	12,5 1500
S24.212.T2 VVG	2x 13 W	G24d-1	28 24	12,5 2200
S24.212.T2 EVG	2x 13 W	G24q-1	28 24	12,5 1900
S24.111.T3	1x 100 W	E27	33 24	13 2100
S24.112.T3	2x 60 W	E27	33 24	13 1900
S24.213.T3 VVG	2x 18 W	G24d-2	33 24	13 2460
S24.213.T3 EVG	2x 18 W	G24q-2	33 24	13 2100
S37.111.T4	2x 75 W	E27	41,5 37	12,5 3100
S37.214.T4 VVG	1x 36 W	2G10	41,5 37	12,5 4200
S37.214.T4 EVG	1x 36 W	2G10	41,5 37	12,5 3900
S37.215.T4 VVG	2x 26 W	G24d-3	41,5 37	12,5 4400
S37.215.T4 EVG	2x 26 W	G24q-3	41,5 37	12,5 3500
S43.111.T5	3x 75 W	E27	50 43	14,5 4800
S43.215.T5 VVG	2x 36 W	2G10	50 43	14,5 6200
S43.215.T5 EVG	2x 36 W	2G10	50 43	14,5 5200

CHARON PLUS
Wei / White

Type	A	B	C	Gewicht Weight
S24.111.T2L	1x 100 W	E27	28 29	12,5 1500
S24.212.T2L VVG	2x 13 W	G24d-1	28 29	12,5 2400
S24.212.T2L EVG	2x 13 W	G24q-1	28 29	12,5 1800
S24.112.T3L	2x 60 W	E27	33 34	13 2450
S24.213.T3L VVG	2x 18 W	G24d-2	33 34	13 2900
S24.213.T3L EVG	2x 18 W	G24q-2	33 34	13 2500
S37.111.T4L	2x 75 W	E27	41,5 43	12,5 3800
S37.215.T4L VVG	2x 26 W	G24d-3	41,5 43	12,5 4700
S37.215.T4L EVG	2x 26 W	G24q-3	41,5 43	12,5 3800
S43.111.T5L	3x 75 W	E27	50 51,5	14,5 5600
S43.215.T5L VVG	2x 36 W	2G10	50 51,5	14,5 6900
S43.215.T5L EVG	2x 36 W	2G10	50 51,5	14,5 5800

Verchromt / Chrom

Type	A	B	C	Gewicht Weight
S24.121.T2L	1x 100 W	E27	28 29	12,5 1500
S24.222.T2L VVG	2x 13 W	G24d-1	28 29	12,5 2400
S24.222.T2L EVG	2x 13 W	G24q-1	28 29	12,5 1800
S24.122.T3L	2x 60 W	E27	33 34	13 2450
S24.223.T3L VVG	2x 18 W	G24d-2	33 34	13 3650
S24.223.T3L EVG	2x 18 W	G24q-2	33 34	13 2200
S37.121.T4L	2x 75 W	E27	41,5 43	12,5 3800
S37.225.T4L VVG	2x 26 W	G24d-3	41,5 43	12,5 5000
S37.225.T4L EVG	2x 26 W	G24q-3	41,5 43	12,5 4300
S43.121.T5L	3x 75 W	E27	50 51,5	14,5 5600
S43.225.T5L VVG	2x 36 W	2G10	50 51,5	14,5 5900
S43.225.T5L EVG	2x 36 W	2G10	50 51,5	14,5 5800

CHARON PLUS

Messing / Brass

Type	A	B	C	Gewicht Weight
S24.131.T2L	1x 100 W	E27	28 29	12,5 1500
S24.232.T2L VVG	2x 13 W	G24d-1	28 29	12,5 2400
S24.232.T2L EVG	2x 13 W	G24q-1	28 29	12,5 1800
S24.132.T3L	2x 60 W	E27	33 34	13 2450
S24.233.T3L VVG	2x 18 W	G24d-2	33 34	13 2900
S24.233.T3L EVG	2x 18 W	G24q-2	33 34	13 2500
S37.131.T4L	2x 75 W	E27	41,5 43	12,5 3800
S37.235.T4L VVG	2x 26 W	G24d-3	41,5 43	12,5 4700
S37.235.T4L EVG	2x 26 W	G24q-3	41,5 43	12,5 3800
S43.131.T5L	3x 75 W	E27	50 51,5	14,5 5600
S43.235.T5L VVG	2x 36 W	2G10	50 51,5	14,5 6900
S43.235.T5L EVG	2x 36 W	2G10	50 51,5	14,5 5800

KALISTO



KALISTO

Weiß / White

Type				A	B	C	D	Gewicht Weight
S2.112	2x 25 W	E14	9	31,5	8	30	1400	
S2.212 VVG	1x 11 W	G23	9	31,5	8	30	1700	
S2.212 EVG	1x 11 W	2G7	9	31,5	8	30	1500	
S2.113	3x 25 W	E14	9	57,5	8	56	1800	
S2.213 VVG	1x 13 W	G5	9	57,5	8	56	2300	
S2.213 EVG	1x 13 W	G5	9	57,5	8	56	2000	

Verchromt / Chrom

Type				A	B	C	D	Gewicht Weight
S2.142	2x 25 W	E14	9	31,5	8	30	1400	
S2.242 VVG	1x 11 W	G23	9	31,5	8	30	1700	
S2.242 EVG	1x 11 W	2G7	9	31,5	8	30	1500	
S2.143	3x 25 W	E14	9	57,5	8	56	1800	
S2.243 VVG	1x 13 W	G5	9	57,5	8	56	2300	
S2.243 EVG	1x 13 W	G5	9	57,5	8	56	2000	

Messing / Brass

Type				A	B	C	D	Gewicht Weight
S2.132	2x 25 W	E14	9	31,5	8	30	1400	
S2.232 VVG	1x 11 W	G23	9	31,5	8	30	1700	
S2.232 EVG	1x 11 W	2G7	9	31,5	8	30	1500	
S2.133	3x 25 W	E14	9	57,5	8	56	1800	
S2.233 VVG	1x 13 W	G5	9	57,5	8	56	2300	
S2.233 EVG	1x 13 W	G5	9	57,5	8	56	2000	

CALYPSO



CALYPSO

Leuchtentyp: Wandleuchte

Schirm: weißes, mundgeblasenes, dreischichtiges Opalglas seidenmatt

Metallteile: weiß lackiertes Stahl- oder Messingblech

Type: Wall lamp

Diffuser: hand blown, triplex-opal glass, matt

Metal part: white painted metal or brass



MAIA 150



MAIA 150

Leuchtentyp: Decken- und Hängeleuchte
Schirm: Glas satiniert in folgenden Farben - weiss, ambra, blau, grün, rot
Metalteile: Chrom

Type: ceiling and suspension lamp
Diffuser: glass satin finish in following colours - white, amber, blue, green, red
Metal part: chrom



MAIA 300

MAIA 300

Leuchtentyp: Tisch-, Steh-, Hänge-, Decken- und Wandleuchte
Schirm: Glas satiniert weiss und ambra
Metalteile: Lack RAL 9006

Type: table, floor, suspension, ceiling and wall lamp
Diffuser: glass satin finish white and amber
Metal part: paint RAL 9006



PROXIMA



PROXIMA

Leuchtentyp: Tisch-, Steh-, Hänge- und Wandleuchte
Schirm: Glas satiniert weiss
Metalleile: Nickel matt

Type: table, floor, suspension and wall lamp
Diffuser: glass satin finish white
Metal part: nickel mat



PROXIMA PLUS

Leuchtentyp: Tisch-, Steh-, Hänge- und Wandleuchte
Schirm: Glas satiniert weiss
Metalleile: Chrom
Fußplatte: Steingut

Type: table, floor, suspension and wall lamp
Diffuser: glass satin finish white
Metal part: chrom
Base: unglazed floor tile



PROXIMA PLUS



RHEA



RHEA

Leuchtentyp: Tisch-, Steh-, Hänge- und Wandleuchte
Schirm: Glas satiniert weiss und ambra
Metallteile: Lack RAL 9006

Type: table, floor, suspension and wall lamp
Diffuser: glass satin finish white and amber
Metal part: paint RAL 9006



SUBRA

Leuchtentyp: Tisch-, Steh-, Hänge- und Wandleuchte
Schirm: Glas satiniert weiss und ambra
Metallteile: Lack RAL 9006

Type: table, floor, suspension and wall lamp
Diffuser: glass satin finish white and amber
Metal part: paint RAL 9006

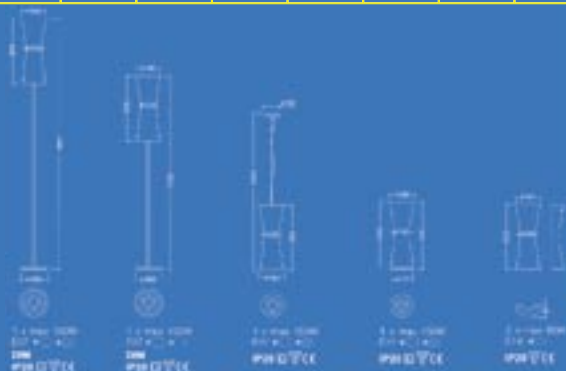

SUBRA



CARMEN



CARMEN

Leuchtentyp: Tisch-, Steh-, Decken- und
Wandleuchte
Schirm: Glas satiniert weiss
Metalleile: Nickel

Type: table, floor, ceiling and wall lamp
Diffuser: glass satin finish white
Metal part: nickel



OMEGA

Leuchtentyp: Tisch-, Steh-, Hänge und
Wandleuchte

Schirm: Glas satiniert in folgenden Farben
- weiss, ambra, blau, grün, rot

Metalteile: Chrom

Fußplatte: Glas

Type: table, floor, suspension and wall lamp

Diffuser: glass satin finish in following
colours - white, amber, blue, green, red

Metal part: chrom

Base: glass



OMEGA



PHOEBE

PHOEBE

Leuchtentyp: Hängeleuchte
 Schirm: Glas satiniert weiss, Kristallglas, mattiertes Kristallglas mit transparentem Rand
 Metallteile: Lack RAL argento dorato

Type: suspension lamp
 Diffuser: glass satin finish white, crystal glass, crystal glass frosted with transparent margin
 Metal part: paint RAL argento dorato

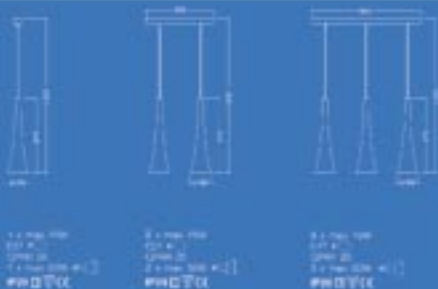

CARINA

Leuchtentyp: Tisch-, Steh-, Hänge- und Wandleuchte
 Schirm: Glas satiniert weiss
 Metallteile: Nickel matt

Type: table, floor, suspension and wall lamp
 Diffuser: glass satin finish white
 Metal part: nickel mat



CARINA



FOMA



FOMA

Leuchtentyp: Tisch-, Steh-, Hänge-, Decken- und Wandleuchte
Schirm: Glas satiniert weiss und ambr
Metallteile: Lack RAL 9006 strukturiert

Type: table, floor, suspension and wall lamp
Diffuser: glass satin finish white and amber
Metal part: paint RAL 9006 structured



Gipsleuchten

Diese hochwertigen Gipsleuchten können mit Farbe angestrichen und mit Wasser abgewaschen werden. Die Wandleuchten können mit einer Glasscheibe abgedeckt werden, aber nur in Verbindung mit Leuchtstofflampen.

Plaster Luminaries

These high and quality plaster luminaries are washable and can be colored with a common wall color. The wall fixtures can be covered with a glass-cover but only when fluorescent lamps are in use.

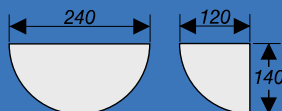

A 100

Code

- 1010 max. 60W, E27
- 1011 10-13W, G24d-1, TC-D
- 1012 10-13W, G24q-1, TC-DEL, E

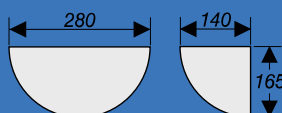
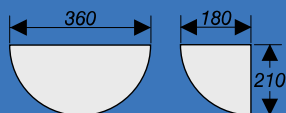

A 101

Code

- 1020 max. 60W, E27
- 1021 100-150W, R7s, QT-DE12, 74,9mm
- 1022 26W, G24d-3, TC-D
- 1023 26W, G24q-3, TC-DEL, E

A 102

Code

- 1030 max. 100W, E27
- 1031 max. 23W, E27, E
- 1032 150 – 300W, R7s, QT-DE12, 114,2mm
- 1033 75W, Rx7s, HIT-DE
- 1034 150W, Rx7s-24, HIT-DE
- 1035 150W, R7s, QT-DE12, 114,2mm
+ 75W, Rx7s, HIT-DE
- 1036 150W, R7s, QT-DE12, 114,2mm
+ 150W, Rx7s-24, HIT-DE
- 1037 26W, G24d-3, TC-D
- 1038 26W, G24d-3, TC-D, EE
- 1039 26W, G24q-3, TC-DEL, E
- 1040 26W, G24q-3, TC-DEL, E, EE
- 1041 2 x 26W, G24d-3, TC-D
- 1042 2 x 26W, G24d-3, TC-D, EE
- 1043 2 x 26W, G24q-3, TC-DEL, E
- 1044 2 x 26W, G24q-3, TC-DEL, E, EE
- 1045 2 x 32W, Gx24q-3, TC-TEL, E
- 1046 2 x 32W, Gx24q-3, TC-TEL, E, EE
- 1047 2 x 32W, Gx24q-3, TC-TEL, DIM ECO
- 1048 2 x 32W, Gx24q-3, TC-TEL, DIM EXCEL

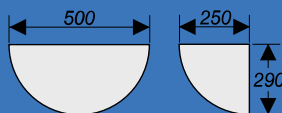

A 103

Code

- 1050 max. 150W, E27
- 1051 150 – 300W, R7s, QT-DE12, 114,2mm
- 1052 75W, Rx7s, HIT-DE
- 1053 150W, Rx7s-24, HIT-DE
- 1054 150W, R7s, QT-DE12, 114,2mm
+ 75W, Rx7s, HIT-DE
- 1055 150W, R7s, QT-DE12, 114,2mm
+ 150W, Rx7s-24, HIT-DE
- 1056 4 x 42W, Gx24q-4, TC-TEL, E
- 1057 4 x 42W, Gx24q-4, TC-TEL, DIM ECO
- 1058 4 x 42W, Gx24q-4, TC-TEL, DIM EXCEL

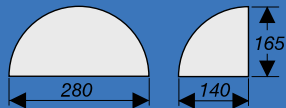

AD 101

Code
1060 26W, G24d-3, TC-T

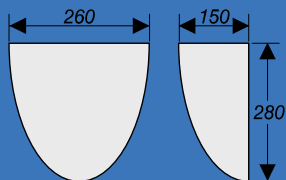

B 104

Code
1070 max. 60W, E27
1071 26W, Gx24d-3, TC-T
1072 26W, G24q-3, TC-TEL, E

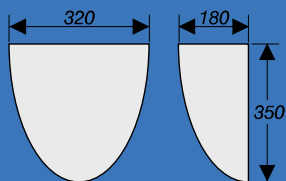

B 105

Code
1075 max. 100W, E27
1076 max. 23W, E27, E
1077 150 – 300W, R7s, QT-DE12, 114,2mm
1078 75W, Rx7s, HIT-DE
1079 150W, Rx7s-24, HIT-DE
1080 26W, G24d-3, TC-D, EE
1081 26W, G24q-3, TC-DEL, E
1082 26W, G24q-3, TC-DEL, E, EE
1083 42W, Gx24q-4, TC-TEL, E
1084 42W, Gx24q-4, TC-TEL, DIM ECO
1085 42W, Gx24q-4, TC-TEL, DIM EXCEL

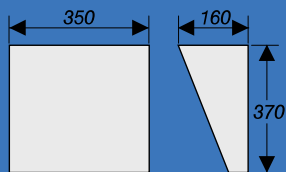

D 109

Code
1145 max. 23W, E27, E
1146 150 – 300W, R7s, QT-DE12, 114,2mm
1147 75W, Rx7s, HIT-DE
1148 150W, Rx7s-24, HIT-DE
1149 26W, G24d-3, TC-D
1150 26W, G24d-3, TC-D, EE
1151 42W, Gx24q-4, TC-DEL, E
1152 42W, Gx24q-4, TC-DEL, DIM ECO
1153 42W, Gx24q-4, TC-DEL, DIM EXCEL

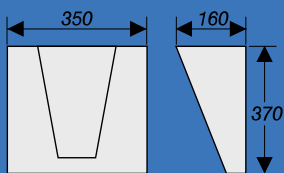

DS 109

Code

- 1160 2 x 18W, 2G11, TC-L
- 1161 2 x 18W, 2G11, TC-L, E
- 1162 2 x 36W, 2G10, TC-F
- 1163 2 x 36W, 2G10, TC-F, E
- 1164 2 x 36W, 2G10, TC-F, DIM ECO
- 1165 2 x 36W, 2G10, TC-F, DIM EXCEL

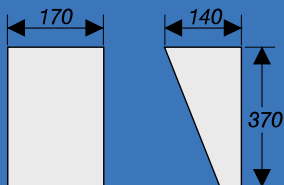

D 159

Code

- 1130 26W, Gx24d-3, TC-T
- 1131 26W, Gx24q-3, TC-TEL, E
- 1132 100-150W, R7s, QT-DE12, 74,9mm

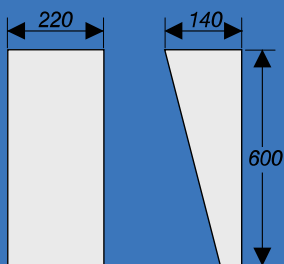

D 156

Code

- 1135 max. 23W, E27, E
- 1136 150 – 300W, R7s, QT-DE12, 114,2mm
- 1137 75W, Rx7s, HIT-DE
- 1138 150W, Rx7s-24, HIT-DE
- 1139 32W, Gx24q-3, TC-TEL, E
- 1140 32W, Gx24q-3, TC-TEL, E, EE
- 1141 32W, Gx24q-3, TC-TEL, DIM ECO
- 1142 32W, Gx24q-3, TC-TEL, DIM EXCEL

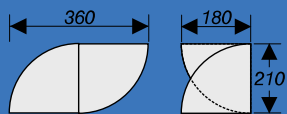
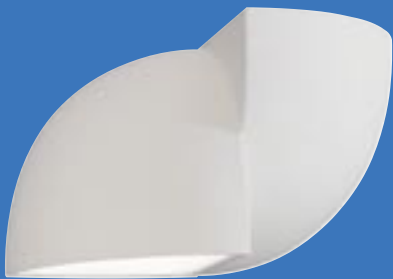

GP 112

Code

- 1195 2 x max. 40W, E27
- 1196 2 x max. 15W, E27, E
- 1197 2 x 26W, G24d-3, TC-D
- 1198 2 x 26W, G24d-3, TC-D, EE
- 1199 2 x 26W, G24q-3, TC-DEL, E

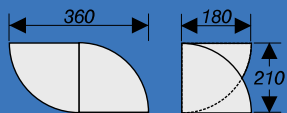

GL 112

Code

- 1190 2 x max. 40W, E27
- 1191 2 x max. 15W, E27, E
- 1192 2 x 26W, G24d-3, TC-D
- 1193 2 x 26W, G24d-3, TC-D, EE
- 1194 2 x 26W, G24q-3, TC-DEL, E

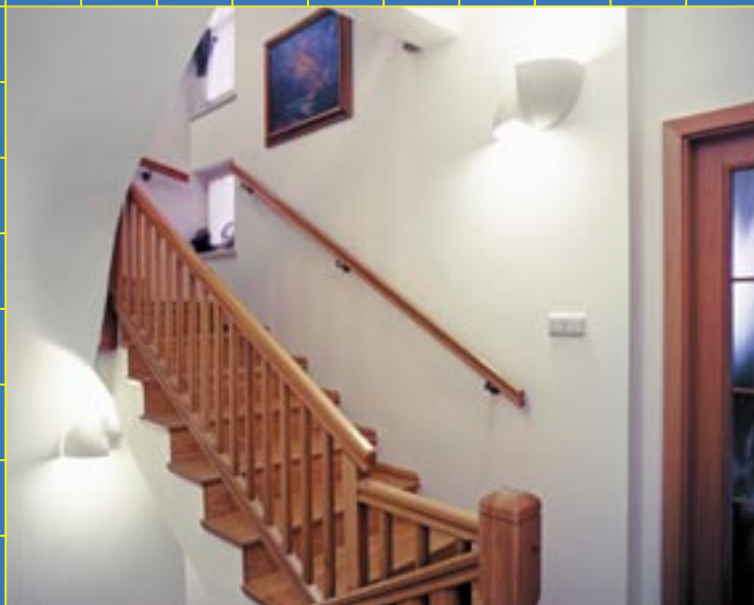

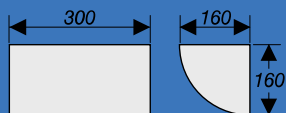

C 106

Code	
1090	max. 100W, E27
1091	max. 23W, E27, E
1092	150 – 300W, R7s, QT-DE12, 114,2mm
1093	75W, Rx7s, HIT-DE
1094	150W, Rx7s-24, HIT-DE
1095	26W, G24d-3, TC-D
1096	26W, G24d-3, TC-D, EE
1097	26W, G24q-3, TC-DEL, E
1098	26W, G24q-3, TC-DEL, E, EE
1099	2 x 26W, G24d-3, TC-D
1100	2 x 26W, G24d-3, TC-D, EE
1101	2 x 32W, Gx24q-3, TC-TEL, E
1102	2 x 32W, Gx24q-3, TC-TEL, DIM ECO
1103	2 x 32W, Gx24q-3, TC-TEL, DIM EXCEL
1104	2 x 32W, Gx24q-3, TC-TEL, E, EE

C 107

Code	
1110	2 x max. 100W, E27
1111	2 x max. 15W, E27, E
1112	36W, 2G11, TC-L
1113	36W, 2G11, TC-L, EE
1114	55W, 2G11, TC-L, E
1115	55W, 2G11, TC-L, E, EE
1116	2 x 55W, 2G11, TC-L, DIM ECO
1117	2 X 55W, 2G11, TC-L, DIM EXCEL

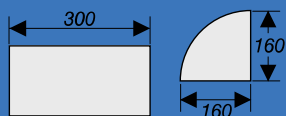
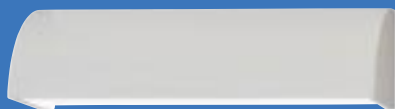
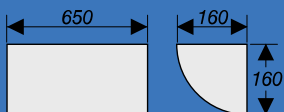

CD 106

Code	
1120	max. 60W, E27
1121	max. 23W, E27, E

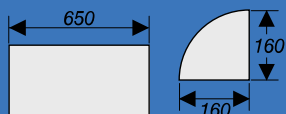

CD 107

Code	
1125	36W, 2G11, TC-L
1126	55W, 2G11, TC-L, E



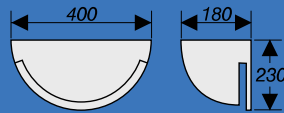

E 110

Code

- 1170 max. 100W, E27
- 1171 max. 23W, E27, **E**
- 1172 26W, G24q-3, TC-TEL, **E**, **EE**
- 1173 2 x 26W, G24d-3, TC-D
+ Gx24d-3, TC-T
- 1174 2 x 32W, Gx24q-3, TC-TEL, **E**

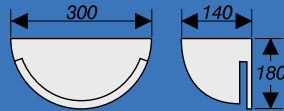

E 125

Code

- 1175 max. 100W, E27
- 1176 26W, G24d-3, TC-D

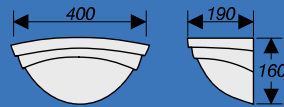

F 111

Code

- 1180 max. 100W, E27
- 1181 150 – 300W, R7s, QT-DE12, 114,2mm
- 1182 26W, G24d-3, TC-D

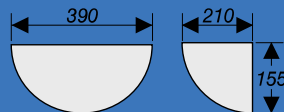

H 113

Code

- 1235/* max. 100W, E27
- 1236/* max. 23W, E27, **E**
- 1237/* 150 – 500W, R7s, QT-DE12, 114,2mm
- 1238/* 75W, Rx7s, HIT-DE
- 1239/* 150W, Rx7s-24, HIT-DE
- 1240/* 150W, R7s, QT-DE12, 114,2mm
+ 75W, Rx7s, HIT-DE
- 1241/* 150W, R7s, QT-DE12, 114,2mm
+ 150W, Rx7s-24, HIT-DE
- 1242/* 26W, G24d-3, TC-D
- 1243/* 26W, G24d-3, TC-D, **EE**
- 1244/* 2 x 26W, G24d-3, TC-D
- 1245/* 2 x 26W, G24d-3, TC-D, **EE**
- 1246/* 2 x 26W, G24q-3, TC-DEL, **E**
- 1247/* 2 x 26W, G24q-3, TC-DEL, **E**, **EE**
- 1248/* 2 x 26W, G24q-3, TC-DEL, DIM ECO
- 1249/* 2 x 26W, G24q-3, TC-DEL, DIM EXCEL

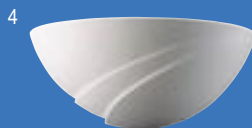

Version H 113	HKP 113	HLL 113	HNP 113	HML 113
*	1	2	3	4
			4	5

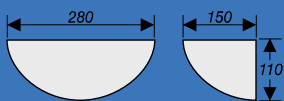

H 151

Code
 1230 max. 60W, E27
 1231 26W, G24d-3, TC-D

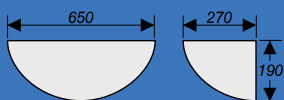

H 152

Code
 1200 2 x max. 100W, E27
 1201 2 x max. 15W, E27, E
 1202 150 – 300W, R7s, QT-DE12, 114,2mm
 1203 75W, Rx7s, HIT-DE
 1204 150W, Rx7s-24, HIT-DE
 1205 150W, R7s, QT-DE12, 114,2mm + 75W, Rx7s, HIT-DE
 1206 150W, R7s, QT-DE12, 114,2mm
 + 150W, Rx7s-24, HIT-DE
 1207 2 x 42W, Gx24q-4, TC-TEL, E
 1208 4 x 42W, Gx24q-4, TC-TEL, E
 1209 4 x 42W, Gx24q-4, TC-TEL, DIM ECO
 1210 4 x 42W, Gx24q-4, TC-TEL, DIM EXCEL
 1211 36W, 2G11, TC-L
 1212 36W, 2G11, TC-L, EE
 1213 36W, 2G11, TC-L, E
 1214 36W, 2G11, TC-L, E, EE



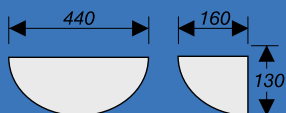

H 168

Code

1260 max. 60W, E27, A40

1261 max. 23W, E27, E

1262 150 – 300W, R7s, QT-DE12, 114,2mm

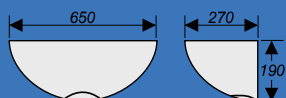

HE 152

Code

1220 2 x max. 100W, E27

1221 2 x max. 15W, E27, E

1222 2 x 42W, Gx24q-4, TC-TEL, E

1223 2 x 42W, Gx24q-4, TC-TEL, DIM ECO

1224 2 x 42W, Gx24q-4, TC-TEL, DIM EXCEL

1225 36W, 2G11, TC-L

1226 36W, 2G11, TC-L, EE

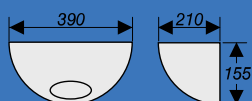
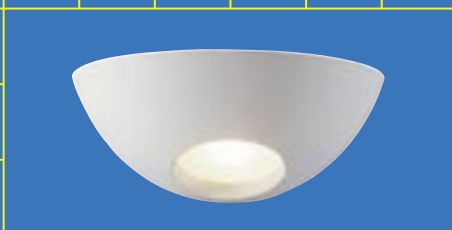

HS 113

Code

1250 max. 100W, E27

1251 max. 23W, E27, E

1252 26W, G24d-3, TC-D

1253 42W, Gx24q-4, TC-TEL, E

1254 42W, Gx24q-4, TC-TEL, DIM ECO

1255 42W, Gx24q-4, TC-TEL, DIM EXCEL

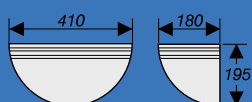

I 114

Code

1265 max. 100W, E27

1266 max. 23W, E27, E

1267 150 – 300W, R7s, QT-DE12, 114,2mm

1268 75W, Rx7s, HIT-DE

1269 150W, Rx7s-24, HIT-DE

1270 150W, R7s, QT-DE12, 114,2mm

+ 75W, Rx7s, HIT-DE

1271 150W, R7s, QT-DE12, 114,2mm

+ 150W, Rx7s-24, HIT-DE

1272 26W, G24d-3, TC-D

1273 26W, G24d-3, TC-D, EE

1274 26W, G24q-3, TC-DEL, E

1275 26W, G24q-3, TC-DEL, E, EE

1276 2 x 26W, G24d-3, TC-D

1277 2 x 26W, G24d-3, TC-D, EE

1278 2 x 26W, G24q-3, TC-DEL, E

1279 2 x 26W, G24q-3, TC-DEL, E, EE

1280 2 x 32W, Gx24q-3, TC-TEL, E

1281 2 x 32W, Gx24q-3, TC-TEL, E, EE

1282 2 x 32W, Gx24q-3, TC-TEL, DIM ECO

1283 2 x 32W, Gx24q-3, TC-TEL, DIM EXCEL

I 157

Code

1285 max. 60W, E27

1286 100-150W, R7s, QT-DE12, 74,9mm

1287 26W, G24d-3, TC-D

1288 26W, G24q-3, TC-DEL, E

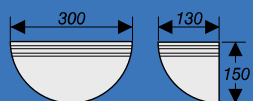

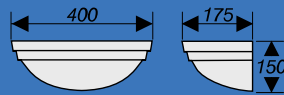
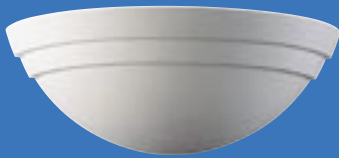

J 115

Code
 1290 max. 60W, E27
 1291 150 – 300W, R7s, QT-DE12, 114,2mm
 1292 26W, G24d-3, TC-D

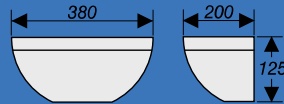

K 147

Code
 1295 max. 100W, E27
 1296 max. 23W, E27, E
 1297 26W, G24d-3, TC-D

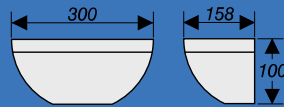

K 158

Code
 1300 max. 60W, E27
 1301 max. 15W, E27, E
 1302 26W, G24d-3, TC-D

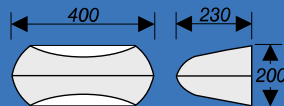

M 145

Code
 1305 2 x max. 100W, E27
 1306 2 x max. 23W, E27, E



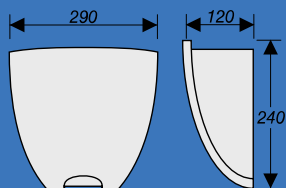
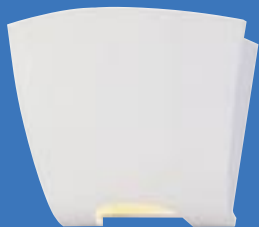

N 143

Code
 1310 max. 100W, E27
 1311 26W, G24d-3, TC-D
 1312 26W, G24q-3, TC-DEL, E

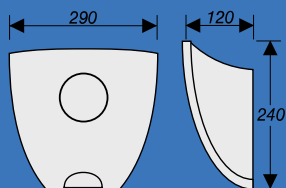

NS 143

Code
 1315 max. 100W, E27
 1316 26W, G24d-3, TC-D
 1317 26W, G24q-3, TC-DEL, E

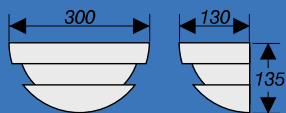
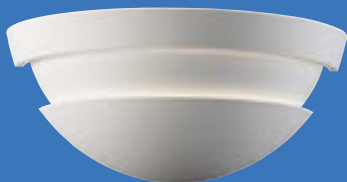

O 150

Code
 1330 max. 60W, E27
 1331 26W, G24d-3, TC-D
 1332 26W, G24q-3, TC-DEL, E

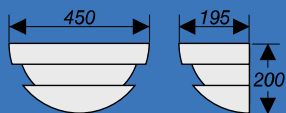

O 120

Code
 1320 max. 100W, E27
 1321 max. 23W, E27, E
 1322 26W, G24d-3, TC-D
 1323 26W, G24q-3, TC-DEL, E
 1324 26W, G24q-3, TC-DEL, DIM ECO
 1325 26W, G24q-3, TC-DEL, DIM EXCEL

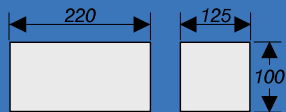

Q 142

Code
 1340 max. 60W, E27
 1341 150 – 300W, R7s, QT-DE12, 74,9mm
 1342 26W, G24d-3, TC-D

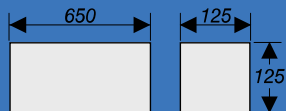

Q 155

Code
 1335 36W, 2G11, TC-L
 1336 55W, 2G11, TC-L, E
 1337 55W, 2G11, TC-L, DIM ECO
 1338 55W, 2G11, TC-L, DIM EXCEL

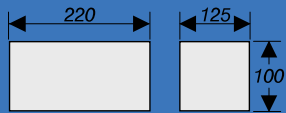
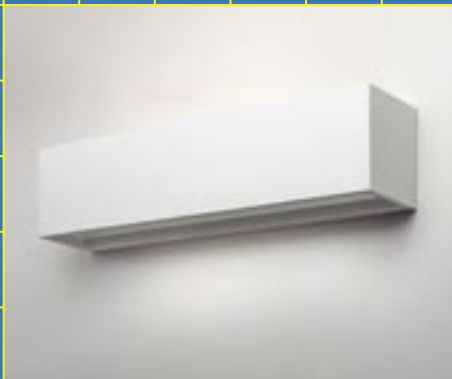

QND 142

Code
 1350 max. 60W, E27
 1351 26W, G24d-3, TC-D

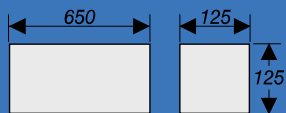

QND 155

Code
 1345 36W, 2G11, TC-L
 1346 55W, 2G11, TC-L, E
 1347 55W, 2G11, TC-L, DIM ECO
 1348 55W, 2G11, TC-L, DIM EXCEL

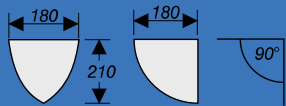
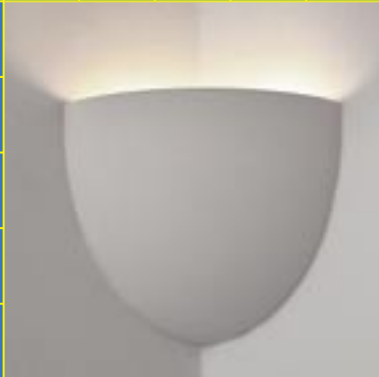

RA 102

Code
 1355 max. 60W, E27
 1356 max. 15W, E27, E

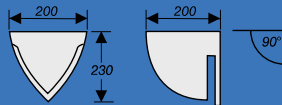

RE 110

Code
1360 max. 60W, E27
1361 max. 15W, E27, E

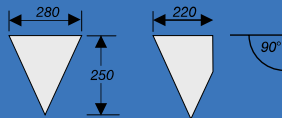

RK 92

Code
1740 max. 100W, E27
1741 max. 23W, E27, E

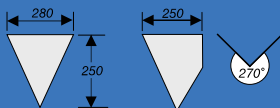

RK 272

Code

1730 2 x max. 60W, E27

1731 2 x max. 15W, E27, E

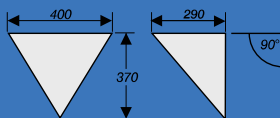
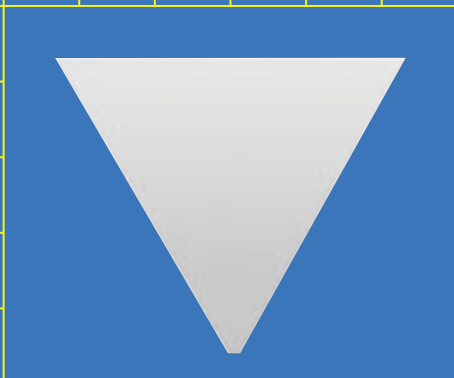

RT 133

Code

1365 max. 60W, E27

1366 max. 15W, E27, E

1367 150 – 300W, R7s, QT-DE12, 74,9mm



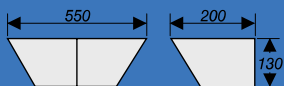

T 144

Code
 1370 max. 100W, E27
 1371 max. 23W, E27, E
 1372 26W, G24d-3, TC-D
 1373 42W, Gx24q-4, TC-TEL, E

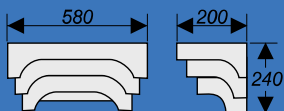
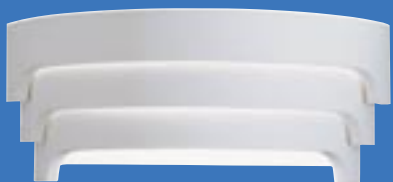

U 128

Code
 1380 2 x max. 100W, E27
 1381 2 x 26W, G24d-3, TC-D + Gx24d-3, TC-T
 1382 2 x 26W, G24q-3, TC-DEL + Gx24q-3, TC-TEL, E, EE
 1383 2 x 32W, Gx24q-3, TC-TEL, E
 1384 2 x 32W, Gx24q-3, TC-TEL, E, EE
 1385 4 x 32W, Gx24q-3, TC-TEL, E
 1386 4 x 32W, Gx24q-3, TC-TEL, DIM ECO
 1387 4 x 32W, Gx24q-3, TC-TEL, DIM EXCEL

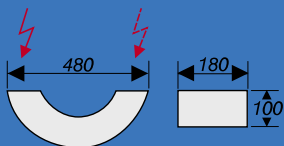

V 129

Code
 1390 max. 100W, E27
 1391 max. 100W, E27 + 10W, G24q-1, TC-DEL, EE
 1392 2 x max. 100W, E27
 1393 2 x max. 23W, E27, E

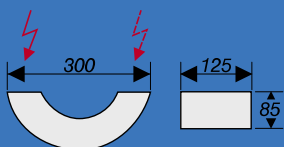

V 153

Code
 1395 max. 60W, E27

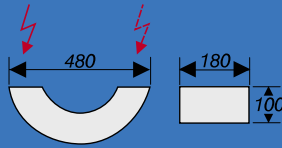

VK 129*

Code
1400/* 2 x max. 100W, E27

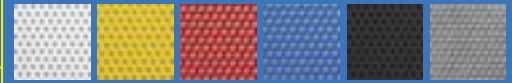

lw ly lr lb lbk ln

Gitter: Metall lackiert / Lattice: colored metal

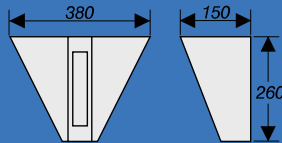

Y 146

Code
1375 18W, 2G11, TC-L
1376 18W, 2G11, TC-L, E

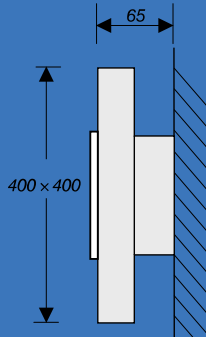

STK 123

Code
1405 2 x 18W, 2G11, TC-L
1406 2 x 18W, 2G11, TC-L, E
1407 4 x 18W, 2G11, TC-L

Mit hochwertigem Keramikgitter / With ceramic lattice

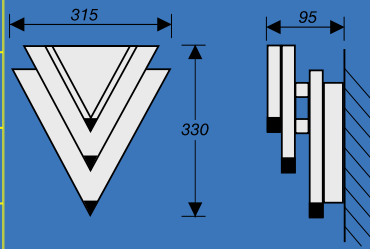

AA 160*

Code
 1420/* max. 100W, E27
 1421/* max. 15W, E27, E
 1422/* 26W, G24d-3, TC-D

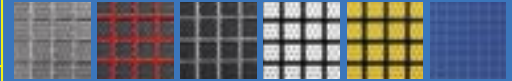

In + IIn lbk + llr lbk + lln lw + llbk ly + llbk lb + llb
 Gitter: Metall lackiert / Lattice: colored metal

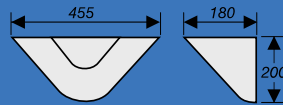

AA 161*

Code
 1425/* max. 100W, E27
 1426/* max. 23W, E27, E
 1427/* 26W, G24d-3, TC-D
 1428/* 42W, Gx24q-4, TC-TEL, E
 1429/* 42W, Gx24q-4, TC-TEL, DIM ECO
 1430/* 42W, Gx24q-4, TC-TEL, DIM EXCEL



y r b g
 Glas: farbig / Glass: colored

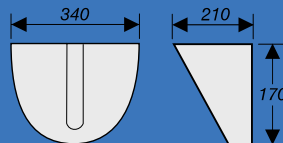

AA 162*

Code
 1431/* max. 100W, E27
 1432/* max. 23W, E27, E
 1433/* 26W, G24d-3, TC-D
 1434/* 42W, Gx24q-4, TC-TEL, E
 1435/* 42W, Gx24q-4, TC-TEL, DIM ECO
 1436/* 42W, Gx24q-4, TC-TEL, DIM EXCEL



y r b g
 Glas: farbig / Glass: colored

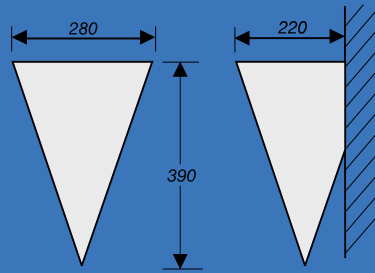

AK 171

Code

- 1700 max. 100W, E27
- 1701 max. 23W, E27, E
- 1702 26W, G24d-3, TC-D
- 1703 26W, G24q-3, TC-DEL, E, EE
- 1704 42W, Gx24q-4, TC-TEL, E
- 1705 42W, Gx24q-4, TC-TEL, DIM ECO
- 1706 42W, Gx24q-4, TC-TEL, DIM EXCEL

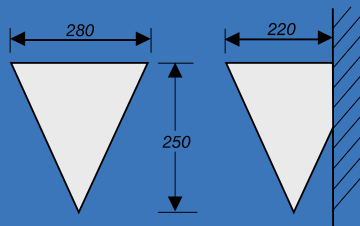

AK 172

Code

- 1713 max. 100W, E27
- 1714 max. 23W, E27, E
- 1715 32W, Gx24q-3, TC-TEL, E
- 1716 32W, Gx24q-3, TC-TEL, DIM ECO
- 1717 32W, Gx24q-3, TC-TEL, DIM EXCEL

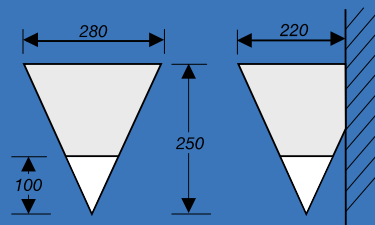

AKS 172

Code

- 1718 max. 100W, E27 + max. 25W, E27
- 1719 max. 23W, E27, E + max. 25W, E27
- 1720 32W, Gx24q-3, TC-TEL, E + max. 25W, E27

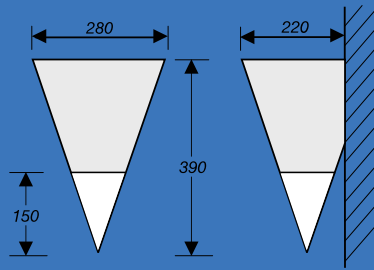
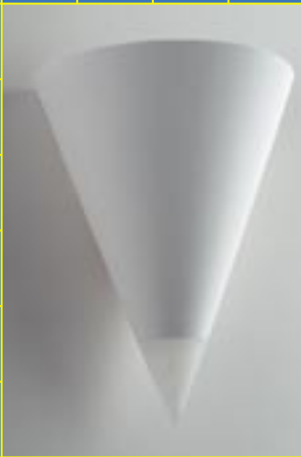

AKS 171

Code

1710 max. 100W, E27 + max. 25W, E27

1711 max. 23W, E27, E + max. 25W, E27

1712 max. 42W, Gx24q-4, TC-TEL, E, + 25W, E27

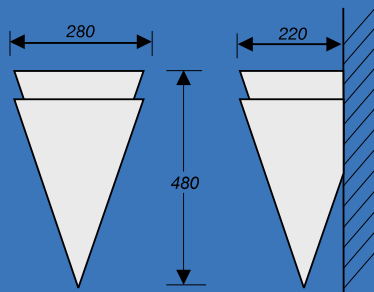

AK 174

Code

1721 max. 100W, E27

1722 max. 23W, E27, E

1723 26W, G24d-3, TC-D

1724 26W, G24q-3, TC-DEL, E

1725 42W, Gx24q-4, TC-TEL, E

1726 42W, Gx24q-4, TC-TEL, DIM ECO

1727 42W, Gx24q-4, TC-TEL, DIM EXCEL

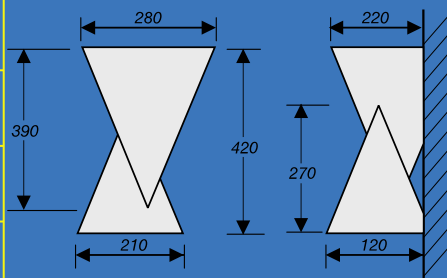

AKG 173

Code

1728 max. 100W, E27 + max. 15W, E27, E

1729 max. 23W, E27, E + 15W, E27, E

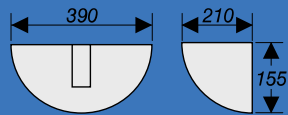

HK 113*

Code

1440/* max. 100W, E27

1441/* max. 23W, E27, E

1442/* 26W, G24d-3, TC-D

1443/* 42W, Gx24q-4, TC-TEL, E

1444/* 42W, Gx24q-4, TC-TEL, DIM ECO

1445/* 42W, Gx24q-4, TC-TEL, DIM EXCEL

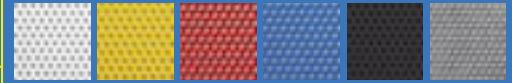

lw ly lr lb lbk ln

Gitter: Metall lackiert / Lattice: colored metal

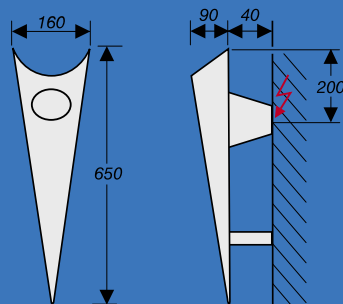
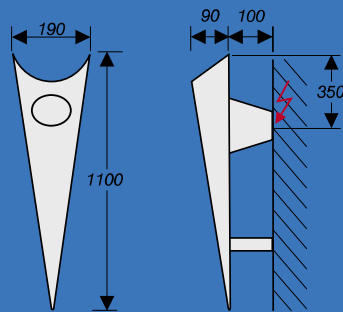

Z 141*

Code

1415/* 2 x max. 150W, E27

1416/* 2 x max. 15W, E27, E

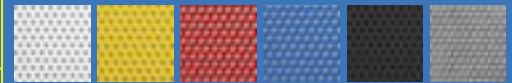

lw ly lr lb lbk ln

Gitter: Metall lackiert / Lattice: colored metal

Z 154*

Code

1417/* 2 x max. 100W, E27

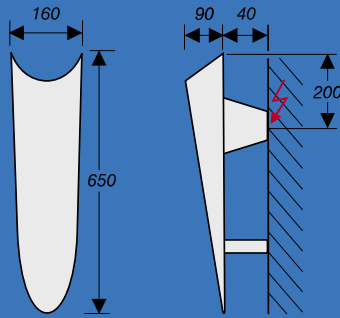

Z 163

Code

1418 2 x max. 100W, E27



SQ 122/*

Code

1500/* 4 x 36W, T8, G13

1501/* 4 x 36W, T8, G13, E

1502/* 4 x 36W, T8, G13, DIM ECO

1503/* 4 x 36W, T8, G13, DIM EXCEL

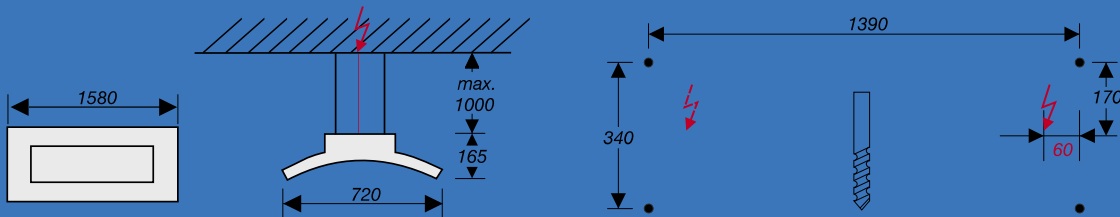

SNV 181

Code

1625 4 x 24W, G5, T5, E

1626 4 x 24W, G5, T5, DIM ECO

1627 4 x 24W, G5, T5, DIM EXCEL

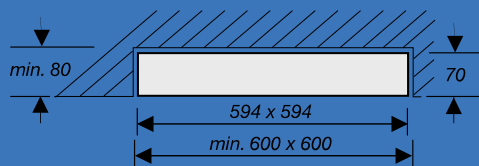
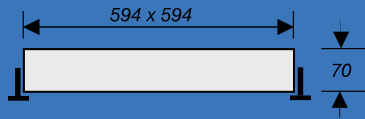

SNZ 180

Code

1620 4 x 24W, G5, T5, E

1621 4 x 24W, G5, T5, DIM ECO

1622 4 x 24W, G5, T5, DIM EXCEL

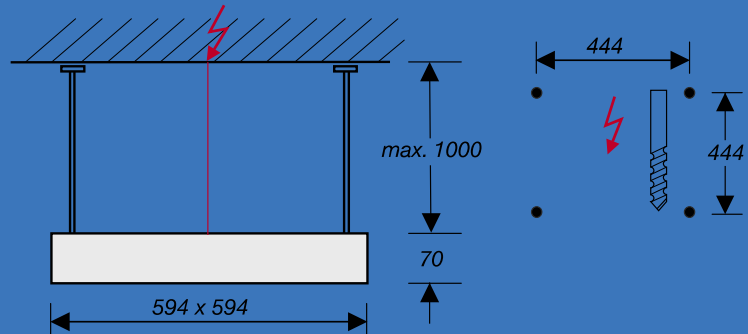



SQT 2000/*

Code

1600/* 4 x 58W, G13, T8
 1601/* 4 x 58W, G13, T8, E
 1602/* 4 x 35W, G5, T5, E, EE
 1603/* 8 x 35W, G5, T5, E
 1604/* 8 x 35W, G5, T5, DIM ECO
 1605/* 8 x 35W, G5, T5, DIM EXCEL



glass lw ln
 Gitter: Metall lackiert / Lattice: colored metal

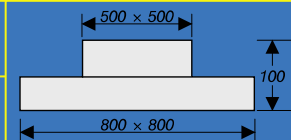
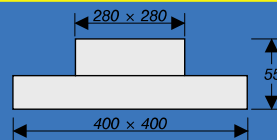
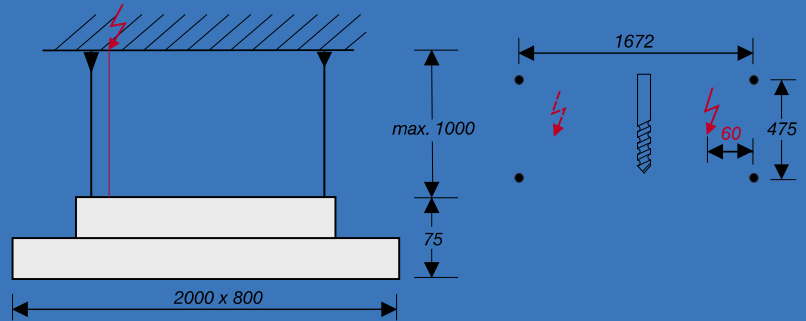

ST 123

Code

1549 2 x 18W, 2G11, TC-L
 1550 2 x 18W, 2G11, TC-L, E
 1551 4 x 18W, 2G11, TC-L

ST 127

Code

1523 4 x 36W, 2G11, TC-L
 1524 4 x 36W, 2G11, TC-L, EE
 1525 4 x 36W, 2G11, TC-L, E
 1526 4 x 36W, 2G11, TC-L, DIM ECO
 1527 4 x 36W, 2G11, TC-L, DIM EXCEL
 1528 4 x 36W, 2G11, TC-L + 4 x 8W, G5, T5
 1529 4 x 36W, 2G11, TC-L, E + 4 x 8W, G5, T5, E
 1530 4 x 36W, 2G11, TC-L, DIM ECO
 + 4 x 8W, G5, T5, E
 1531 4 x 36W, 2G11, TC-L, DIM EXCEL
 + 4 x 8W, G5, T5, E
 1532 6 x 36W, 2G11, TC-L
 1533 6 x 36W, 2G11, TC-L, E
 1534 6 x 36W, 2G11, TC-L, DIM ECO
 1535 6 x 36W, 2G11, TC-L, DIM EXCEL
 1536 6 x 36W, 2G11, TC-L + 4 x 8W, G5, T5
 1537 6 x 36W, 2G11, TC-L, E + 4 x 8W, G5, T5

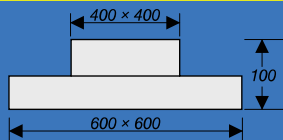

ST 126

Code

1540 4 x 24W, 2G11, TC-L
 1541 4 x 24W, 2G11, TC-L, E
 1542 4 x 24W, 2G11, TC-L, DIM ECO
 1543 4 x 24W, 2G11, TC-L, DIM EXCEL
 1544 4 x 24W, 2G11, TC-L + 4 x 8W, G5, T5
 1545 4 x 24W, 2G11, TC-L, E + 4 x 8W, G5, T5, E
 1546 4 x 24W, 2G11, TC-L, DIM ECO + 4 x 8W, G5, T5, E
 1547 4 x 24W, 2G11, TC-L, DIM EXCEL + 4 x 8W, G5, T5, E



STO 127

Code
 1565 4 x 36W, 2G11, TC-L
 1566 4 x 36W, 2G11, TC-L, **EE**
 1567 4 x 36W, 2G11, TC-L, **E**
 1568 4 x 36W, 2G11, TC-L, **DIM ECO**
 1569 4 x 36W, 2G11, TC-L, **DIM EXCEL**

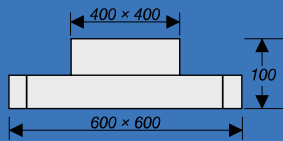

STO 126

Code
 1570 4 x 24W, 2G11, TC-L
 1571 4 x 24W, 2G11, TC-L, **E**
 1572 4 x 24W, 2G11, TC-L, **DIM ECO**
 1573 4 x 24W, 2G11, TC-L, **DIM EXCEL**

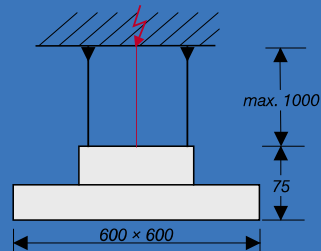
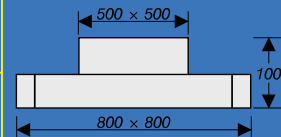

STZ 126

Code
 1560 4 x 24W, 2G11, TC-L
 1561 4 x 24W, 2G11, TC-L, **E**
 1562 4 x 24W, 2G11, TC-L, **DIM ECO**
 1563 4 x 24W, 2G11, TC-L, **DIM EXCEL**

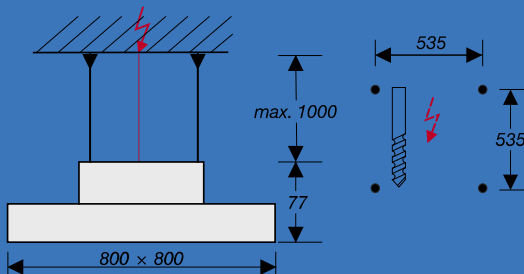
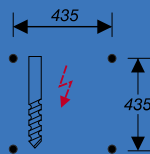

STZ 127

Code
 1555 4 x 36W, 2G11, TC-L
 1556 4 x 36W, 2G11, TC-L, **EE**
 1557 4 x 36W, 2G11, TC-L, **E**
 1558 4 x 36W, 2G11, TC-L, **DIM ECO**
 1559 4 x 36W, 2G11, TC-L, **DIM EXCEL**



SV 124

Code

1575 4 x max. 100W, E27 + 9W, G23, TC blue

1576 4 x max. 23W, E27, E + 9W, G23, TC blue

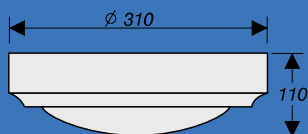
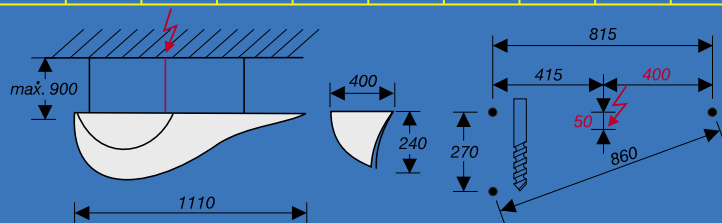

SA 148

Code

1520 max. 60W, E27

1521 13W, G24d-1, TC-D

1522 13W, G24q-1, TC-DEL, E



SA 149

Code

1517 2 x max. 60W, E27

1518 2 x 26W, G24d-3, TC-D

1519 2 x 26W, G24q-3, TC-DEL, E

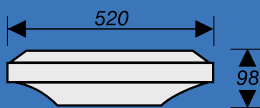

SYP 136

Code

1590 2 x max. 60W, E27

1591 2 x 26W, G24d-3, TC-D

1592 2 x 26W, G24q-3, TC-DEL, E



SY 136

Code

- 1511 2 x max. 60W, E27
- 1512 2 x 26W, G24d-3, TC-D
- 1513 2 x 26W, G24q-3, TC-DEL, E

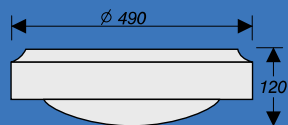

SY 135

Code

- 1505 3 x max. 60W, E27
- 1506 2 x 36W, 2G10, TC-F
- 1507 2 x 36W, 2G10, TC-F, EE
- 1508 2 x 36W, 2G10, TC-F, E
- 1509 2 x 36W, 2G10, TC-F, DIM ECO
- 1510 2 x 36W, 2G10, TC-F, DIM EXCEL



SY 137

Code

- 1514 max. 60W, E27
- 1515 13W, G24d-1, TC-D
- 1516 13W, G24q-1, TC-DEL, E

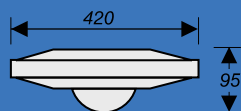

SYJ 137

Code

- 1585 max. 60W, E27
- 1586 13W, G24d-1, TC-D
- 1587 13W, G24q-1, TC-DEL, E



SX 138

Code

1580 4 x max. 60W, E27

1581 4 x max. 23W, E27, E

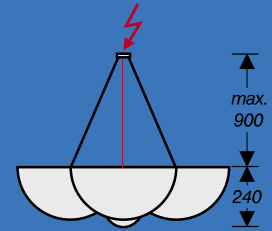
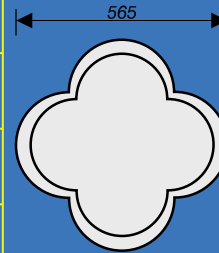

SD 236

Code

1610 250W, E27, QT32

1611 75W, E27, HIE

1612 70W, E27, HIT

1613 73W, E27, HI-PAR

1614 150W, E27, HIE

1615 70W, E27, HSE

1616 70W, E27, HST

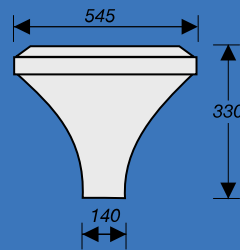

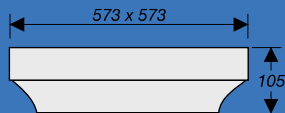

SP 70/*

Code

- 1630/* 4 x 36W, 2G11, TC-L
- 1631/* 4 x 36W, 2G11, TC-L, **EE**
- 1632/* 4 x 36W, 2G11, TC-L, **E**
- 1633/* 4 x 36W, 2G11, TC-L, DIM ECO
- 1634/* 4 x 36W, 2G11, TC-L, DIM EXCEL
- 1635/* 6 x 36W, 2G11, TC-L, **E**
- 1636/* 6 x 36W, 2G11, TC-L, DIM ECO
- 1637/* 6 x 36W, 2G11, TC-L, DIM EXCEL



glass lw ln
Gitter: Metall lackiert / Lattice: colored metal

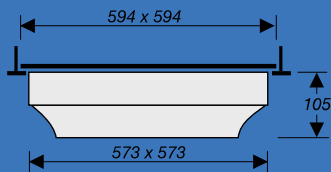

SR 80/*

Code

- 1657/* 4 x 36W, 2G11, TC-L
- 1658/* 4 x 36W, 2G11, TC-L, **EE**
- 1659/* 4 x 36W, 2G11, TC-L, **E**
- 1660/* 4 x 36W, 2G11, TC-L, DIM ECO
- 1661/* 4 x 36W, 2G11, TC-L, DIM EXCEL
- 1662/* 6 x 36W, 2G11, TC-L, **E**
- 1663/* 6 x 36W, 2G11, TC-L, DIM ECO
- 1664/* 6 x 36W, 2G11, TC-L, DIM EXCEL

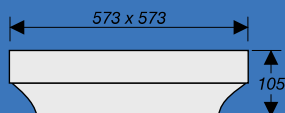

SP 71/*

Code

- 1640 4 x 24W, 2G11, TC-L
- 1641 4 x 24W, 2G11, TC-L, **EE**
- 1642 4 x 24W, 2G11, TC-L, **E**
- 1643 4 x 24W, 2G11, TC-L, DIM ECO
- 1644 4 x 24W, 2G11, TC-L, DIM EXCEL



glass lw ln
Gitter: Metall lackiert / Lattice: colored metal

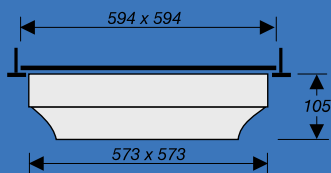

SR 81/*

Code

- 1665 4 x 24W, 2G11, TC-L
- 1666 4 x 24W, 2G11, TC-L, **EE**
- 1667 4 x 24W, 2G11, TC-L, **E**
- 1668 4 x 24W, 2G11, TC-L, DIM ECO
- 1669 4 x 24W, 2G11, TC-L, DIM EXCEL

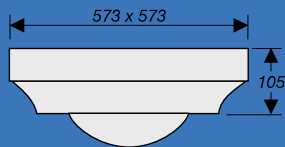
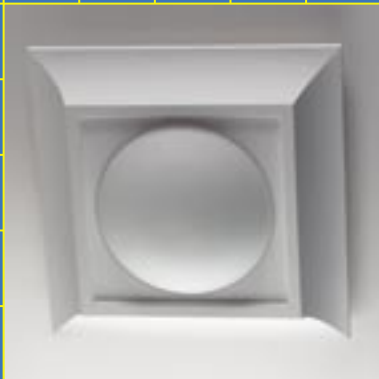

SP 72

- Code
 1645 4 x 24W, 2G11, TC-L
 1646 4 x 24W, 2G11, TC-L, **EE**
 1647 4 x 24W, 2G11, TC-L, **E**
 1648 4 x 24W, 2G11, TC-L, DIM ECO
 1649 4 x 24W, 2G11, TC-L, DIM EXCEL

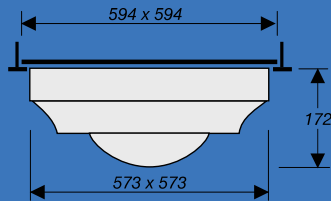

SR 82

- Code
 1670 4 x 24W, 2G11, TC-L
 1671 4 x 24W, 2G11, TC-L, **EE**
 1672 4 x 24W, 2G11, TC-L, **E**
 1673 4 x 24W, 2G11, TC-L, DIM ECO
 1674 4 x 24W, 2G11, TC-L, DIM EXCEL

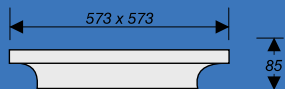

SP 74/*

- Code
 1653 2 x 36W, 2G10, TC-F
 1654 2 x 36W, 2G10, TC-F, **E**
 1655 2 x 36W, 2G10, TC-F, DIM ECO
 1656 2 x 36W, 2G10, TC-F, DIM EXCEL

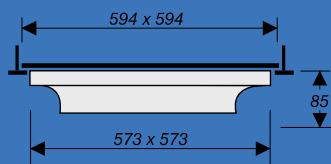

SR 84/*

- Code
 1678 2 x 36W, 2G10, TC-F
 1679 2 x 36W, 2G10, TC-F, **E**
 1680 2 x 36W, 2G10, TC-F, DIM ECO
 1681 2 x 36W, 2G10, TC-F, DIM EXCEL



glass lw ln
 Gitter: Metall lackiert / Lattice: colored metal

AR 308
Code 3001

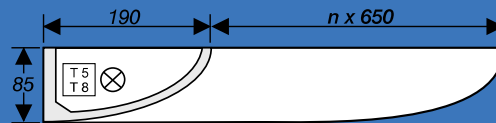
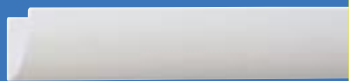

BR 408
Code 3002

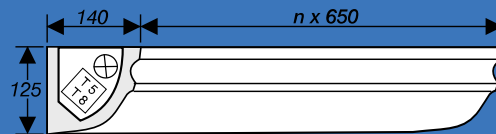

CR 108
Code 3003

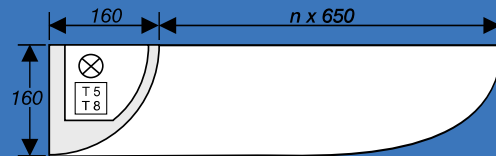
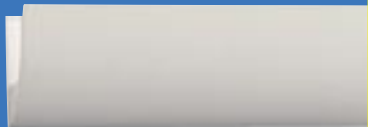

CRL 108
Code 3004

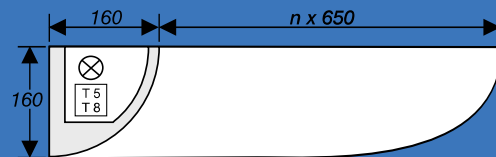
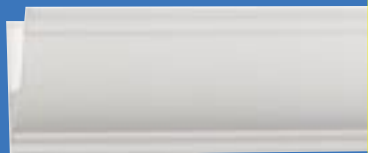

PR 208
Code 3006

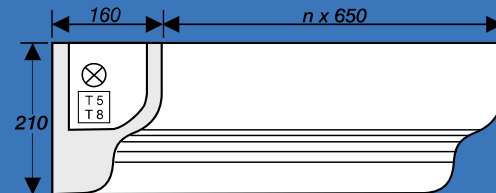
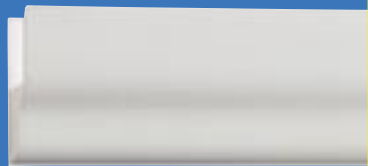



PRL 208
Code 3007

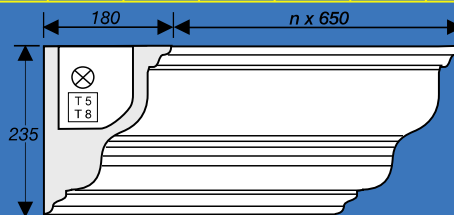

QR 608
Code 3008

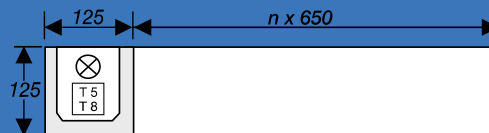
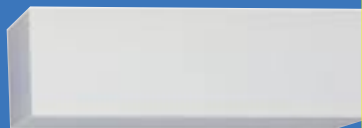

DRD 508
Code 3010

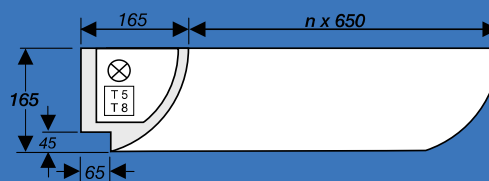
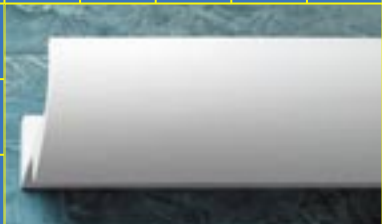

CRT 108
Code 3005

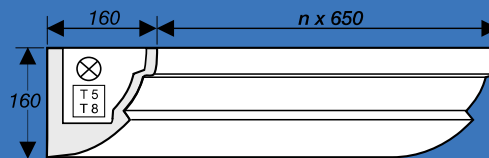

KR 250
Code 3012

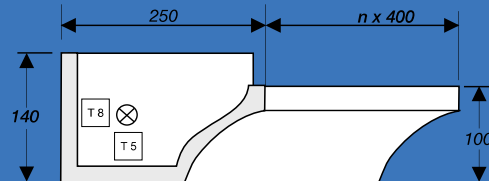

ER 220
Code 3013

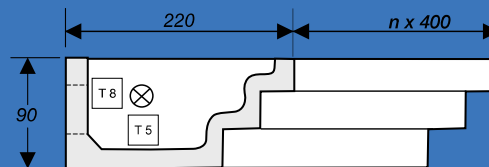

FR 280
Code 3014

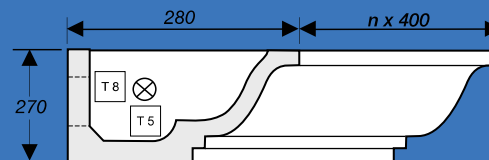

GR 300
Code 3015

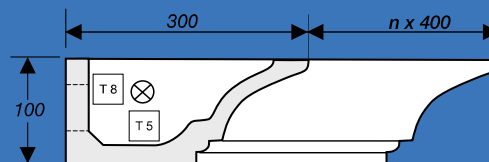

JR 333
Code 3011

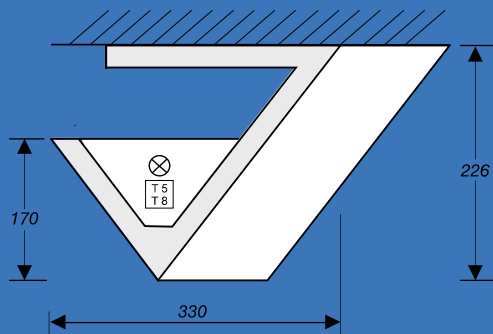

RR 110
Code 3017

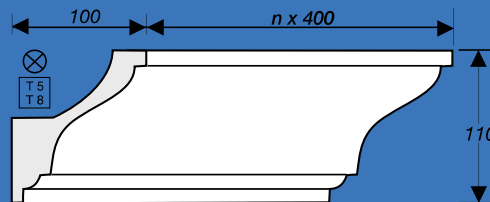
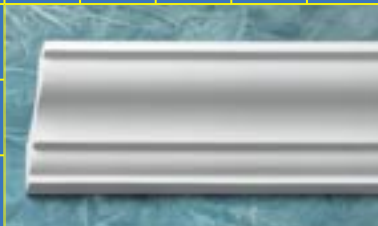

UR 130
Code 3019

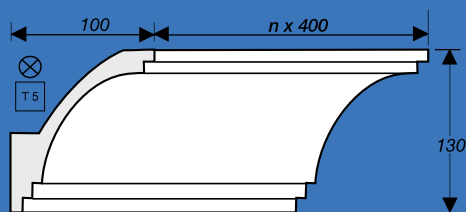
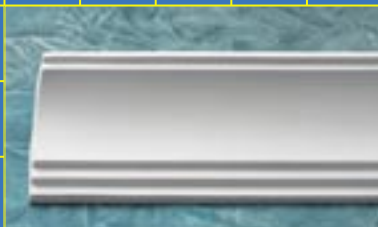

VR 100
Code 3020

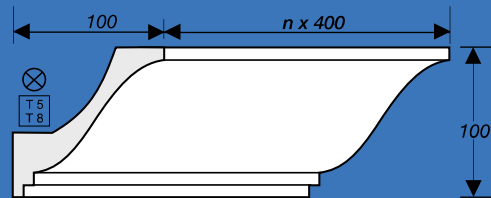
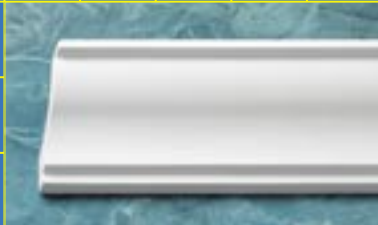

YR 111
Code 3021

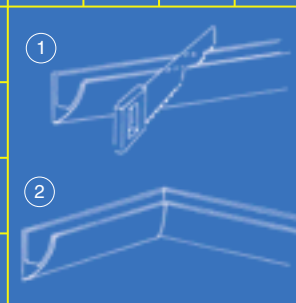
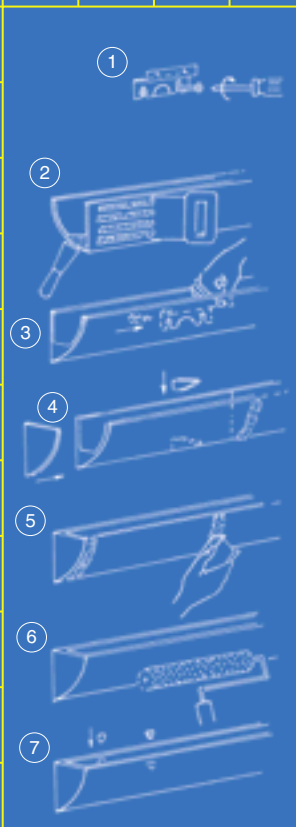
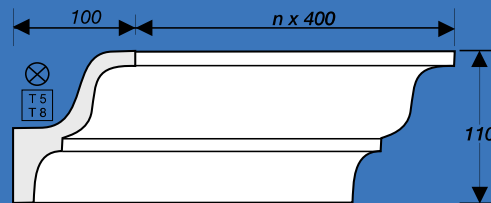

Weitere Infos auf der CD
For more info see
the CD Montage Video



MP-Leuchten

MP-Leuchten

Vogtlandstr. 2
93176 Beratzhausen
Germany

Telefon: +49-9493-900 50

Fax: +49-9493-900 51

Mobil: +49-171-525 22 58

E-mail: verkauf@mp-leuchten.com

Internet: www.mp-leuchten.com